

GA-K8N51PVM9-RH-NV

AMD Socket 939 Processor Motherboard

User's Manual

Rev. 1004

12ME-N51PVM9R-1004R



* The WEEE marking on the product indicates this product must not be disposed of with user's other household waste and must be handed over to a designated collection point for the recycling of waste electrical and electronic equipment!!



* The WEEE marking applies only in European Union's member states.

Declaration of Conformity

We, Manufacturer/importer

G.B.T. Technology Trading GmbH
Ausschleisslager Weg 4 42699 Solingen, Germany

(full address)

(description of the apparatus, system, installation to which it refers)

Motherboard

GA-K8N51PVM9-RH-NV

(reference to the specification under which conformity is declared)
is in conformity with
in accordance with 90/269 EEC-EMC Directive

EN 55011 Limits and methods of measurement of radio disturbance characteristics of industrial, scientific and medical (ISM) high frequency equipment

EN 61000-3-2
 EN 61000-3-3

Disturbances in supply systems caused by household appliances and similar electrical equipment "Voltage fluctuations"

EN 55013 Limits and methods of measurement of radio disturbance characteristics of equipment

EN 55024

Information Technology equipment/Immunity measurement

EN 55014-1 Limits and methods of measurement of radio disturbance characteristics of household electrical appliances, portable tools and similar electrical apparatus

EN 50082-1
 EN 50082-2

Generic immunity standard Part 1: Residential, commercial and light industry
Generic immunity standard Part 2: Industrial environment

EN 55015 Limits and methods of measurement of radio disturbance characteristics of television sets and luminaires

EN 55014-2

Immunity requirements for household appliances tools and similar apparatus

EN 55020 Immunity from radio interference of equipment

EN 50091-1-2

EMC requirements for uninterruptible power systems (UPS)

EN 55022 Limits and methods of measurement of radio disturbance characteristics of information technology equipment

DIN VDE 0885
 Part 1
 Part 12

Cabled distribution systems; Equipment for power supply systems from sound and television signals

CE marking



(EC conformity marking)

The manufacturer also declares the conformity of above mentioned product with the safety requirements in accordance with LVD 702/95 EEC

EN 60065

Safety requirements for mains operated household and similar general use

EN 60950

Safety for information technology equipment including electrical business equipment

EN 60335

Safety of household and similar electrical appliances

EN 50091-1

General and Safety requirements for uninterruptible power systems (UPS)

Manufacturer/Importer

Signature: *Jimmy Huang*

(Stamp)

Date: Mar. 02, 2006

Name: Timmy Huang

DECLARATION OF CONFORMITY

Per FCC Part 2, Section 2.1077(a)



Responsible Party Name: G.B.T. INC. (U.S.A.)

Address: 17358 Railroad Street

City of Industry, CA 91748

Phone/Fax No: (818) 854-9338 / (818) 854-9339

hereby declares that the product

Product Name: Motherboard

Model Number: GA-K8N51PVM9-RH-NV

Conforms to the following specifications:

FCC Part 15, Subpart B, Section 15.107(a) and Section 15.109

(a), Class B Digital Device

Supplementary Information:

This device complies with part 15 of the FCC Rules. Operation is subject to the following two conditions: (1) This device may not cause harmful and (2) this device must accept any interference received, including that may cause undesired operation.

Representative Person's Name: ERIC LU

Signature: *Eric Lu*

Date: Mar. 02, 2006

Copyright

© 2005 GIGA-BYTE TECHNOLOGY CO., LTD. All rights reserved.

The trademarks mentioned in the manual are legally registered to their respective companies.

Notice

The written content provided with this product is the property of Gigabyte.

No part of this manual may be reproduced, copied, translated, or transmitted in any form or by any means without Gigabyte's prior written permission. Specifications and features are subject to change without prior notice.

Product Manual Classification

In order to assist in the use of this product, Gigabyte has categorized the user manual in the following:

- For detailed product information and specifications, please carefully read the "Product User Manual".

- For detailed information related to Gigabyte's unique features, please go to the "Technology Guide" section on Gigabyte's website to read or download the information you need.

For more product details, please click onto Gigabyte's website at www.gigabyte.com.tw

Table of Contents

| | |
|----------------------------------------------------|----|
| Item Checklist | 6 |
| Optional Accessories | 6 |
| GA-K8N51PVM9-RH-NV Motherboard Layout | 7 |
| Block Diagram | 8 |
| | |
| Chapter 1 Hardware Installation | 9 |
| 1-1 Considerations Prior to Installation | 9 |
| 1-2 Feature Summary | 10 |
| 1-3 Installation of the CPU and CPU Cooler | 12 |
| 1-3-1 Installation of the CPU | 12 |
| 1-3-2 Installation of the CPU Cooler | 13 |
| 1-4 Installation of Memory | 14 |
| 1-5 Installation of Expansion Cards | 16 |
| 1-6 I/O Back Panel Introduction | 17 |
| 1-7 Connectors Introduction | 18 |
| | |
| Chapter 2 BIOS Setup | 29 |
| The Main Menu (For example: BIOS Ver. : F3d) | 30 |
| 2-1 Standard CMOS Features | 32 |
| 2-2 Advanced BIOS Features | 34 |
| 2-3 Integrated Peripherals | 36 |
| 2-4 Power Management Setup | 39 |
| 2-5 PnP/PCI Configurations | 41 |
| 2-6 PC Health Status | 42 |
| 2-7 Frequency/Voltage Control | 44 |
| 2-8 Security Chip Configuration | 45 |
| 2-9 Load Fail-Safe Defaults | 45 |
| 2-10 Load Optimized Defaults | 46 |
| 2-11 Set Supervisor/User Password | 46 |
| 2-12 Save & Exit Setup | 47 |
| 2-13 Exit Without Saving | 47 |

| | |
|-----------------------------------------------------------------------------|----|
| Chapter 3 Drivers Installation | 49 |
| 3-1 Install Chipset Drivers | 49 |
| 3-2 Software Application | 50 |
| 3-3 Software Information | 50 |
| 3-4 Hardware Information | 51 |
| 3-5 Contact Us | 51 |
| 3-6 Dual-Monitor Setup | 52 |
| | |
| Chapter 4 Appendix | 55 |
| 4-1 Unique Software Utilities | 55 |
| 4-1-1 EasyTune 5 Introduction | 55 |
| 4-1-2 Xpress Recovery2 Introduction | 56 |
| 4-1-3 Flash BIOS Method Introduction | 58 |
| 4-1-4 Configuring SATA Hard Drive(s) (Controller: nVIDIA nForce4 430) | 67 |
| 4-1-5 2- / 4- / 6- / 8- Channel Audio Function Introduction | 81 |
| 4-1-6 Introduction of the TPM Security Solution | 86 |
| 4-2 Troubleshooting | 87 |

Item Checklist

- IDE Cable x 1 & FDD Cable x 1
- Serial ATAII Cable x 1
- I/O Shield

* The items listed above are for reference only, and are subject to change without notice.

Optional Accessories

- ◆ 2 Ports USB 2.0 Cable (Part Number: 12CR1-1UB030-51/ 51R)

GA-K8N51PVM9-RH-NV Motherboard Layout

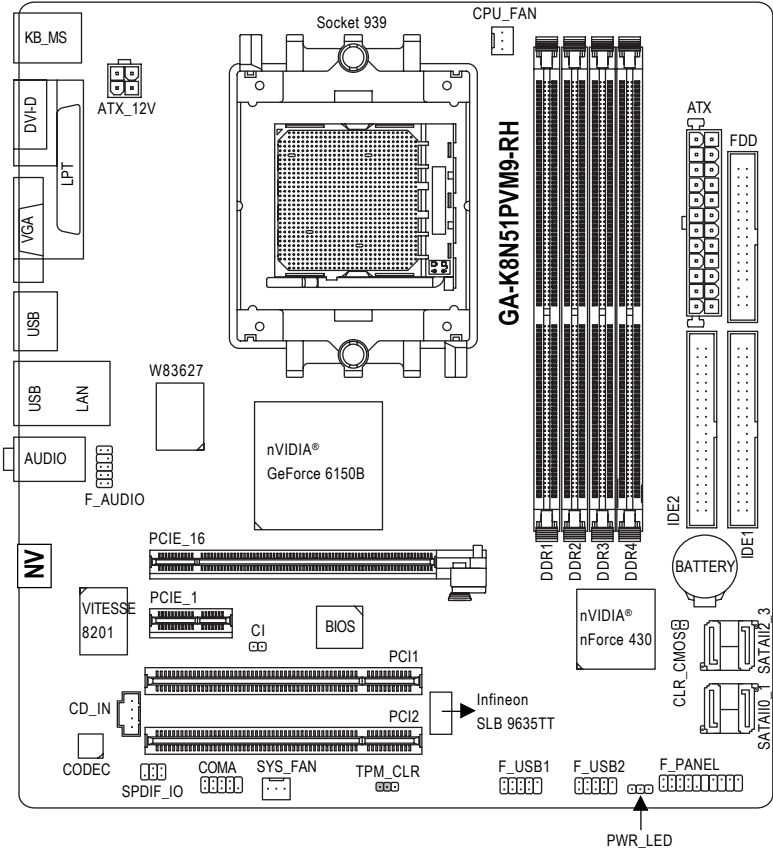

Block Diagram

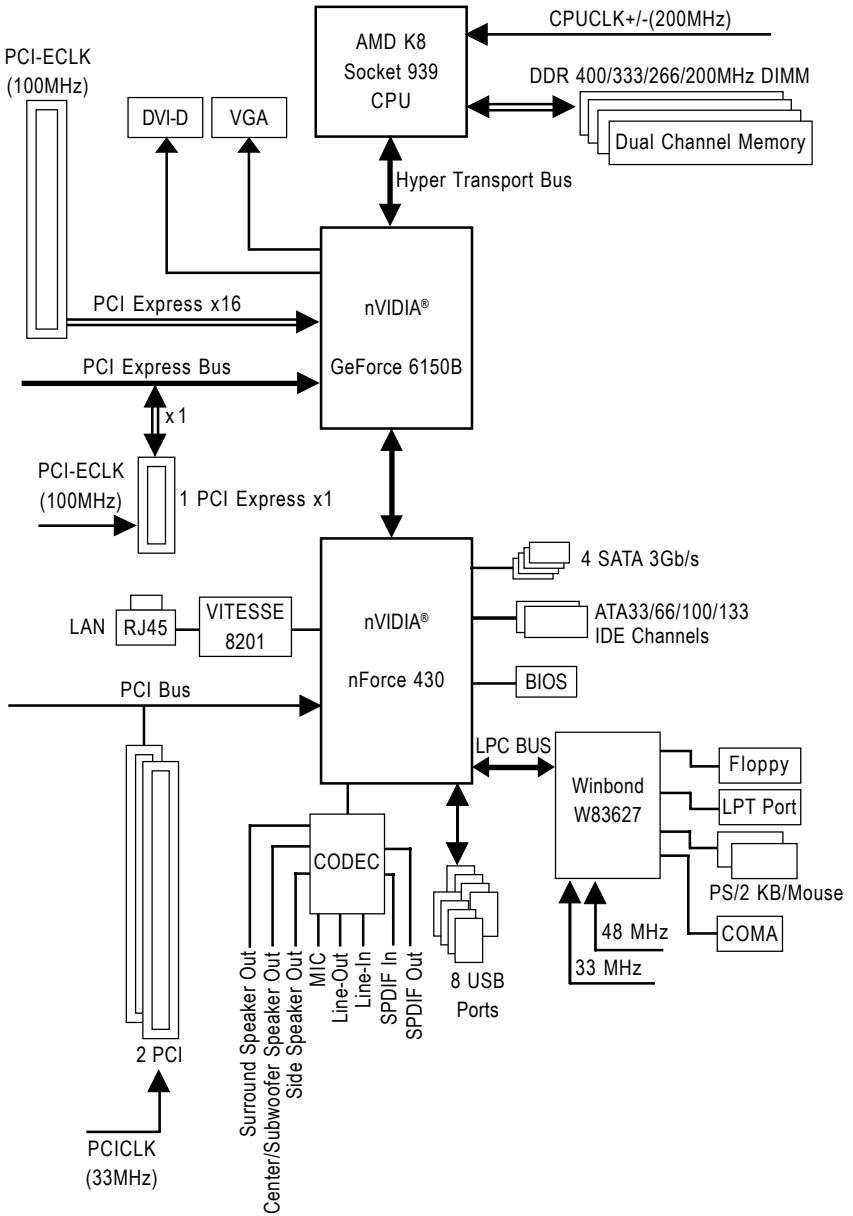

Chapter 1 Hardware Installation

1-1 Considerations Prior to Installation

Preparing Your Computer

The motherboard contains numerous delicate electronic circuits and components which can become damaged as a result of electrostatic discharge (ESD). Thus, prior to installation, please follow the instructions below:

1. Please turn off the computer and unplug its power cord.
2. When handling the motherboard, avoid touching any metal leads or connectors.
3. It is best to wear an electrostatic discharge (ESD) cuff when handling electronic components (CPU, RAM).
4. Prior to installing the electronic components, please have these items on top of an antistatic pad or within a electrostatic shielding container.
5. Please verify that the power supply is switched off before unplugging the power supply connector from the motherboard.

Installation Notices

1. Prior to installation, please do not remove the stickers on the motherboard. These stickers are required for warranty validation.
2. Prior to the installation of the motherboard or any hardware, please first carefully read the information in the provided manual.
3. Before using the product, please verify that all cables and power connectors are connected.
4. To prevent damage to the motherboard, please do not allow screws to come in contact with the motherboard circuit or its components.
5. Please make sure there are no leftover screws or metal components placed on the motherboard or within the computer casing.
6. Please do not place the computer system on an uneven surface.
7. Turning on the computer power during the installation process can lead to damage to system components as well as physical harm to the user.
8. If you are uncertain about any installation steps or have a problem related to the use of the product, please consult a certified computer technician.

Instances of Non-Warranty

1. Damage due to natural disaster, accident or human cause.
2. Damage as a result of violating the conditions recommended in the user manual.
3. Damage due to improper installation.
4. Damage due to use of uncertified components.
5. Damage due to use exceeding the permitted parameters.
6. Product determined to be an unofficial Gigabyte product.

1-2 Feature Summary

| | |
|---------------------|-------------------------------------------------------------------------------------------------------------------------------------------------------------------------------------------------------------------------------------------------------------------------------------------------------------------------------------------------------------------------------------------------------------------------------------------------------------------------------------------------------------------------------------------------------------------------------------------|
| CPU | <ul style="list-style-type: none"> Supports Socket 939 for AMD Athlon™ 64 / 64 FX processor (K8) |
| Front Side Bus | <ul style="list-style-type: none"> 2000MHz Supports core frequencies in excess of 3000+ and faster |
| Chipset | <ul style="list-style-type: none"> Northbridge: nVIDIA® GeForce 6150B Chipset Southbridge: nVIDIA® nForce 430 |
| LAN | <ul style="list-style-type: none"> Onboard VITESSE 8201 phy (10/100/1000 Mbit) |
| Audio | <ul style="list-style-type: none"> Onboard Realtek ALC880 CODEC chip Supports 2 / 4 / 6/ 8 channel audio ^(Note 1) Supports Line In / Line Out / MIC In Supports SPDIF In/Out connection Supports CD In connection |
| Onboard VGA | <ul style="list-style-type: none"> Built-in nVIDIA® GeForce 6150B Chipset |
| Storage | <ul style="list-style-type: none"> nVIDIA® nForce 430 Southbrigde <ul style="list-style-type: none"> 1 FDD connector, allowing connection of 1 FDD device 2 IDE connectors (IDE1, IDE2) with UDMA 33/ATA 66/ATA 100/ATA 133 support, allowing connection of 4 IDE devices 4 SATA 3Gb/s connectors (SATAII0_1, SATAII2_3), allowing connection of 4 SATA 3Gb/s devices Supports data striping (RAID 0), mirroring (RAID 1) for Serial ATA |
| O.S Support | <ul style="list-style-type: none"> Microsoft Windows 2000/XP |
| Memory | <ul style="list-style-type: none"> 4 DDR DIMM memory slots (supports up to 4 GB memory) ^(Note 2) Supports dual channel DDR 400/333/266/200 DIMM Supports 2.5V DDR DIMMs |
| Expansion Slots | <ul style="list-style-type: none"> 1 PCI Express x16 slot 1 PCI Express x1 slot 2 PCI slots |
| Internal Connectors | <ul style="list-style-type: none"> 1 24-pin ATX power connector 1 4-pin ATX 12V power connector 1 floppy connector 2 IDE connectors 4 SATA 3Gb/s connectors 1 CPU fan connector 1 system fan connector 1 front panel connector 1 front audio connector 1 CD In connector 1 SPDIF In/Out connector 1 COMA connector 2 USB 2.0/1.1 connectors for additional 4 ports by cables 1 TPM_CLR connector 1 PWR_LED connector 1 CI connector |

| | |
|---------------------|------------------------------------------------------------------------------------------------------------------------------------------------------------------------------------------------------------------------------------------------------------------------------------------------------------------------------------------------------------------------|
| Rear Panel I/O | <ul style="list-style-type: none"> ◆ 1 PS/2 keyboard port ◆ 1 PS/2 mouse port ◆ 1 parallel port ◆ 1 DVI-D port ◆ 1 VGA port ◆ 4 USB 2.0/1.1 ports ◆ 1 RJ-45 port ◆ 3 audio jacks (Line In / Line Out / MIC In) |
| I/O Control | <ul style="list-style-type: none"> ◆ Winbond W83627 chip |
| Hardware Monitor | <ul style="list-style-type: none"> ◆ System voltage detection ◆ CPU / System temperature detection ◆ CPU / System fan speed detection ◆ CPU warning temperature ◆ CPU / System fan failure warning ◆ Supports CPU Smart Fan function ^(Note 3) |
| BIOS | <ul style="list-style-type: none"> ◆ 1 4M bit flash ROM ◆ Use of licensed AWARD BIOS |
| Additional Features | <ul style="list-style-type: none"> ◆ Supports @BIOS ◆ Supports Download Center ◆ Supports Q-Flash ◆ Supports EasyTune ^(Note 4) ◆ Supports Xpress Install ◆ Supports Xpress Recovery2 ◆ Supports Xpress BIOS Rescue ◆ Supports TCG 1.2 compliant trusted platform module (TPM) |
| Bundle Software | <ul style="list-style-type: none"> ◆ Norton Internet Security (OEM version) |
| Form Factor | <ul style="list-style-type: none"> ◆ Micro ATX form factor; 24.4cm x 24.4cm |

(Note 1) To achieve 8-Channel Audio output, you have to connect the front panel audio module to the F_AUDIO connector on the motherboard. Then set the type of equipment from the audio software. The audio module should be the HD (High Definition) specification.

(Note 2) Due to standard PC architecture, a certain amount of memory is reserved for system usage and therefore the actual memory size is less than the stated amount.
For example, 4 GB of memory size will instead be shown as 3.xxGB memory during system startup.

(Note 3) Whether the CPU Smart FAN Control function is supported will depend on the CPU you install.

(Note 4) EasyTune functions may vary depending on different motherboards.

1-3 Installation of the CPU and CPU Cooler



Before installing the CPU, please comply with the following conditions:

1. Please make sure that the motherboard supports the CPU.
2. Please take note of the pin 1 marking (the small triangle) on the CPU. If you install the CPU in the wrong direction, the CPU will not insert properly. If this occurs, please change the insert direction of the CPU.
3. Please add an even layer of heat paste between the CPU and CPU cooler.
4. Please make sure the CPU cooler is installed on the CPU prior to system use, otherwise overheating and permanent damage of the CPU may occur.
5. Please set the CPU host frequency in accordance with the processor specifications. It is not recommended that the system bus frequency be set beyond hardware specifications since it does not meet the required standards for the peripherals. If you wish to set the frequency beyond the proper specifications, please do so according to your hardware specifications including the CPU, graphics card, memory, hard drive, etc.

1-3-1 Installation of the CPU

Check the CPU pins to see that none are bent. Move the socket lever to the unlocked position as shown in Fig. 1 (90° to the plane of the motherboard) prior to inserting the CPU. The pin 1 location is designated on the CPU by a small triangle that corresponds to a triangle marking on the socket as shown in Fig. 2. Align the CPU to the socket and gently lower it into place. Do not force the CPU into the socket.

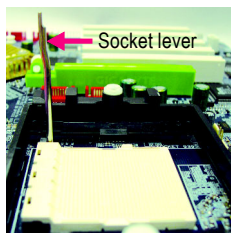

Fig.1
Position lever at a 90 degree angle.

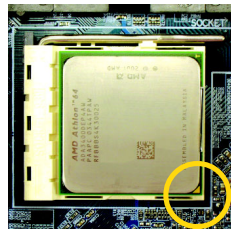

Fig.2
Pin 1 location on the socket and processor.
Gently place the CPU into position making sure that the CPU pins fit perfectly into their holes. Once the CPU is positioned into its socket, place one finger down on the middle of the CPU and gently press the metal lever back into its original position.



Please use extra care when installing the CPU. The CPU will not fit if positioned incorrectly. Rather than applying force, please change the positioning of the CPU.

1-3-2 Installation of the CPU Cooler

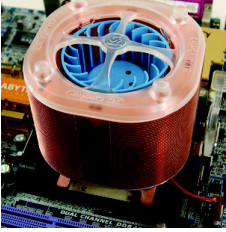

Fig.1

Before installing the CPU cooler, please first add an even layer of heat paste on the surface of the CPU. Install all the CPU cooler components (Please refer to the cooler manual for detailed installation instructions).

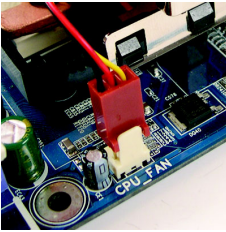

Fig.2

Please connect the CPU cooler power connector to the CPU_FAN connector located on the motherboard so that the CPU cooler can properly function to prevent CPU overheating.



NOTE

The CPU cooler may adhere to the CPU as a result of hardening of the heat paste. To prevent such an occurrence, it is suggested that either thermal tape rather than heat paste be used for heat dissipation or using extreme care when removing the CPU cooler.

1-4 Installation of Memory



Before installing the memory modules, please comply with the following conditions:

1. Please make sure that the memory used is supported by the motherboard. It is recommended that memory of similar capacity, specifications and brand be used.
2. Before installing or removing memory modules, please make sure that the computer power is switched off to prevent hardware damage.
3. Memory modules have a foolproof insertion design. A memory module can be installed in only one direction. If you are unable to insert the module, please switch the direction.

The motherboard supports DDR memory modules, whereby BIOS will automatically detect memory capacity and specifications. Memory modules are designed so that they can be inserted only in one direction. The memory capacity used can differ with each slot.

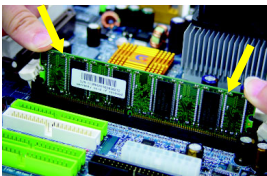
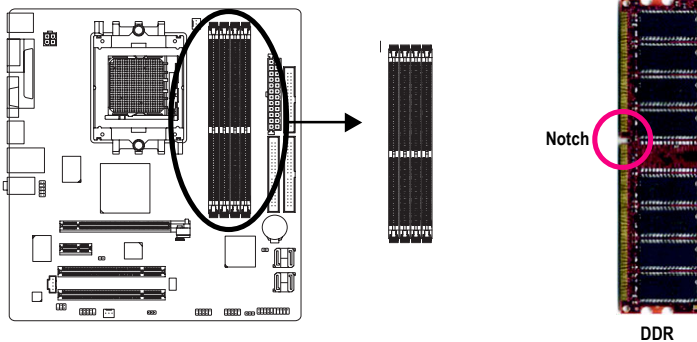

Fig.1

The DIMM socket has a notch, so the DIMM memory module can only fit in one direction. Insert the DIMM memory module vertically into the DIMM socket. Then push it down.



Fig.2

Close the plastic clip at both edges of the DIMM sockets to lock the DIMM module.

Reverse the installation steps when you wish to remove the DIMM module.

Dual Channel Memory Configuration

The GA-K8N51PVM9-RH-NV supports the Dual Channel Technology. After operating the Dual Channel Technology, the bandwidth of Memory Bus will double.

Due to CPU limitation, if you wish to operate the Dual Channel Technology, follow the guidelines below:

1. Dual Channel mode will not be enabled if only one DDR memory module is installed.
2. To enable Dual Channel mode with 2 memory modules (it is recommended to use memory modules of identical brand, size, chips, and speed), you must install them into DIMM sockets of the same color.
3. To enable Dual Channel mode with 4 memory modules, it is recommended to use memory modules of identical brand, size, chips, and speed.

The following is a Dual Channel Memory configuration table: (DS: Double Side, SS: Single Side)

| | DDR1 | DDR2 | DDR3 | DDR4 |
|------------------|-------|-------|-------|-------|
| 2 memory modules | DS/SS | DS/SS | X | X |
| | X | X | DS/SS | DS/SS |
| 4 memory modules | DS/SS | DS/SS | DS/SS | DS/SS |



NOTE

If two memory modules are to be used to achieve Dual Channel mode, we recommend installing them in DDR1 and DDR2 DIMM sockets.



CAUTION

All of the memory configurations below will cause system unable to boot.
(DS: Double Side, SS: Single Side)

| | DDR1 | DDR2 | DDR3 | DDR4 |
|------------------|-------|-------|-------|-------|
| 1 memory module | X | DS/SS | X | X |
| | X | X | X | DS/SS |
| 2 memory modules | X | DS/SS | DS/SS | X |
| | DS/SS | X | X | DS/SS |
| | X | DS/SS | X | DS/SS |
| 3 memory modules | DS/SS | DS/SS | DS/SS | X |
| | X | DS/SS | DS/SS | DS/SS |
| | DS/SS | X | DS/SS | DS/SS |
| | DS/SS | DS/SS | X | DS/SS |

1-5 Installation of Expansion Cards

You can install your expansion card by following the steps outlined below:

1. Read the related expansion card's instruction document before install the expansion card into the computer.
2. Remove your computer's chassis cover, screws and slot bracket from the computer.
3. Press the expansion card firmly into expansion slot in motherboard.
4. Be sure the metal contacts on the card are indeed seated in the slot.
5. Replace the screw to secure the slot bracket of the expansion card.
6. Replace your computer's chassis cover.
7. Power on the computer, if necessary, setup BIOS utility of expansion card from BIOS.
8. Install related driver from the operating system.

Installing a PCI Express x16 expansion card:

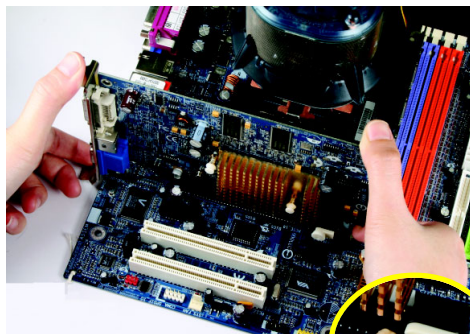

CAUTION

Please carefully pull out the small white-drawable bar at the end of the PCI Express x16 slot when you try to install/uninstall the VGA card. Please align the VGA card to the onboard PCI Express x16 slot and press firmly down on the slot. Make sure your VGA card is locked by the small white-drawable bar.

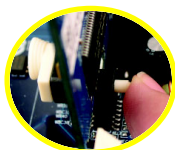

To release an installed card, users can also press the latch on the opposite side of the drawable bar as the picture to the left shows.

1-6 I/O Back Panel Introduction

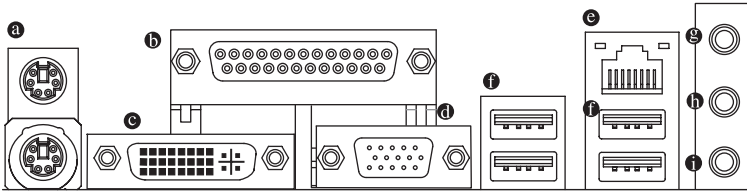

❶ PS/2 Keyboard and PS/2 Mouse Connector

To install a PS/2 port keyboard and mouse, plug the mouse to the upper port (green) and the keyboard to the lower port (purple).

❷ Parallel Port

The parallel port allows connection of a printer, scanner and other peripheral devices.

❸ DVI-D Port

Digital monitor can be connected to this DVI-D port.

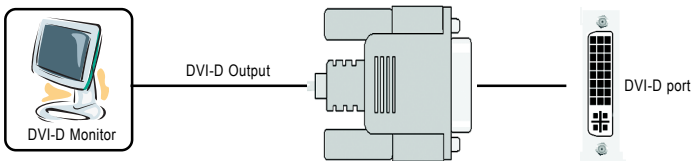

❹ VGA Port

15-pin VGA monitor can be connected to the VGA port.

❺ LAN Port

The provided Internet connection is Gigabit Ethernet , providing data transfer speeds of 10/100/1000Mbps.

❻ USB port

Before you connect your device(s) into USB connector(s), please make sure your device(s) such as USB keyboard, mouse, scanner, zip, speaker...etc. have a standard USB interface. Also make sure your OS supports USB controller. If your OS does not support USB controller, please contact OS vendor for possible patch or driver upgrade. For more information please contact your OS or device(s) vendors.

❼ Line In

The default Line In jack. Devices like CD-ROM, walkman etc. can be connected to Line In jack.

❽ Line Out (Front Speaker Out)

The default Line Out jack. Connect the stereo speakers, earphone or front surround channels to this connector.

❾ MIC In

The default MIC In jack. Microphone must be connected to MIC In jack.

1-7 Connectors Introduction

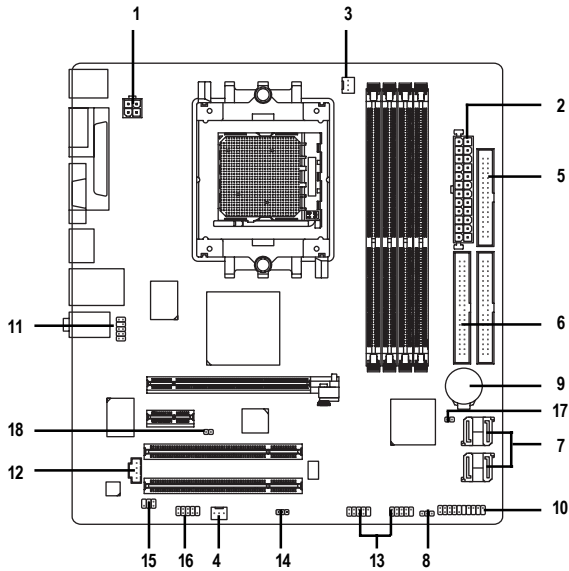

| | |
|--------------------------|---------------------|
| 1) ATX_12V | 10) F_PANEL |
| 2) ATX (Power Connector) | 11) F_AUDIO |
| 3) CPU_FAN | 12) CD_IN |
| 4) SYS_FAN | 13) F_USB1 / F_USB2 |
| 5) FDD | 14) TPM_CLR |
| 6) IDE1 / IDE2 | 15) SPDIF_IO |
| 7) SATAII0_1 / SATAII2_3 | 16) COMA |
| 8) PWR_LED | 17) CLR_CMOS |
| 9) BATTERY | 18) CI |

1/2) ATX_12V / ATX (Power Connector)

With the use of the power connector, the power supply can supply enough stable power to all the components on the motherboard. Before connecting the power connector, please make sure that all components and devices are properly installed. Align the power connector with its proper location on the motherboard and connect tightly.

The ATX_12V power connector mainly supplies power to the CPU. If the ATX_12V power connector is not connected, the system will not start.

Caution!

Please use a power supply that is able to handle the system voltage requirements. It is recommended that a power supply that can withstand high power consumption be used (300W or greater). If a power supply is used that does not provide the required power, the result can lead to an unstable system or a system that is unable to start.

If you use a 24-pin ATX power supply, please remove the small cover on the power connector on the motherboard before plugging in the power cord; otherwise, please do not remove it.

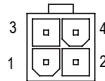
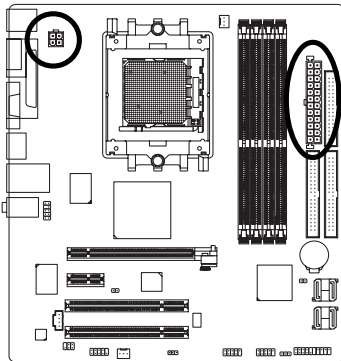

| Pin No. | Definition |
|---------|------------|
| 1 | GND |
| 2 | GND |
| 3 | +12V |
| 4 | +12V |

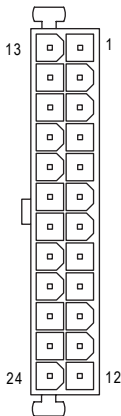

| Pin No. | Definition | Pin No. | Definition |
|---------|---------------------------|---------|---------------------------|
| 1 | 3.3V | 13 | 3.3V |
| 2 | 3.3V | 14 | -12V |
| 3 | GND | 15 | GND |
| 4 | +5V | 16 | PS_ON(soft On/Off) |
| 5 | GND | 17 | GND |
| 6 | +5V | 18 | GND |
| 7 | GND | 19 | GND |
| 8 | Power Good | 20 | -5V |
| 9 | 5V SB(stand by +5V) | 21 | +5V |
| 10 | +12V | 22 | +5V |
| 11 | +12V(Only for 24-pin ATX) | 23 | +5V (Only for 24-pin ATX) |
| 12 | 3.3V(Only for 24-pin ATX) | 24 | GND(Only for 24-pin ATX) |

3/4) CPU_FAN / SYS_FAN (Cooler Fan Power Connector)

The cooler fan power connector supplies a +12V power voltage via a 3-pin power connector and possesses a foolproof connection design.

Most coolers are designed with color-coded power connector wires. A red power connector wire indicates a positive connection and requires a +12V power voltage. The black connector wire is the ground wire (GND).

Remember to connect the CPU/system fan cable to the CPU_FAN/SYS_FAN connector to prevent CPU damage or system hanging caused by overheating.

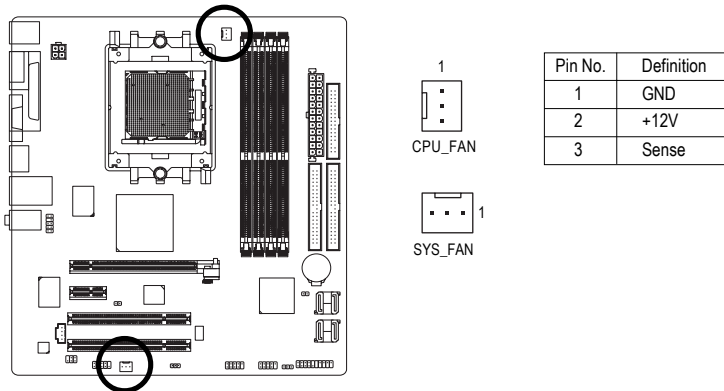

5) FDD (FDD Connector)

The FDD connector is used to connect the FDD cable while the other end of the cable connects to the FDD drive. The types of FDD drives supported are: 360KB, 720KB, 1.2MB, 1.44MB and 2.88MB. Before attaching the FDD cable, please take note of the foolproof groove in the FDD connector.

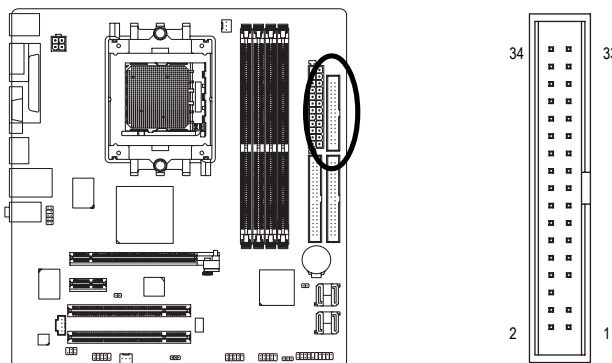

6) IDE1 / IDE2 (IDE Connector)

An IDE device connects to the computer via an IDE connector. One IDE connector can connect to one IDE cable, and the single IDE cable can then connect to two IDE devices (hard drive or optical drive). If you wish to connect two IDE devices, please set the jumper on one IDE device as Master and the other as Slave (for information on settings, please refer to the instructions located on the IDE device). Before attaching the IDE cable, please take note of the foolproof groove in the IDE connector.

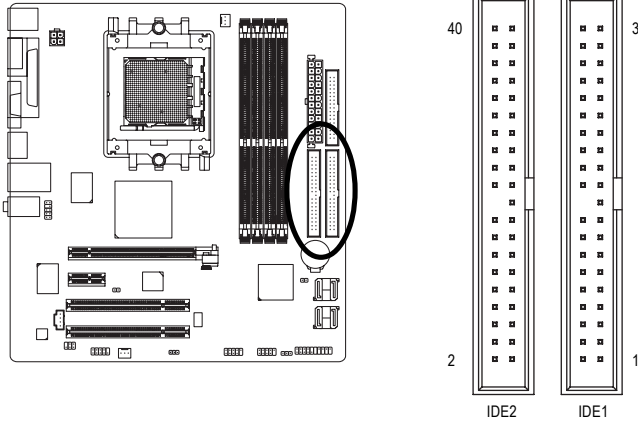

7) SATAII0 / 1 / 2 / 3 (SATA 3Gb/s Connectors, Controlled by nForce 430)

SATA 3Gb/s can provide up to 300MB/s transfer rate. Please refer to the BIOS setting for the SATA 3Gb/s and install the proper driver in order to work properly.

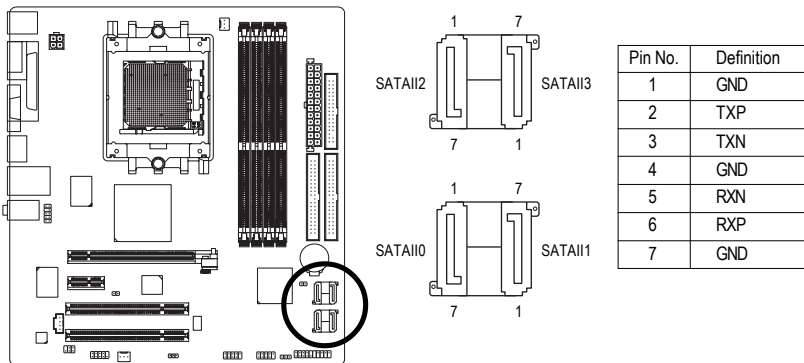

8) PWR_LED

The PWR_LED connector is connected with the system power indicator to indicate whether the system is on/off. It will blink when the system enters suspend mode.

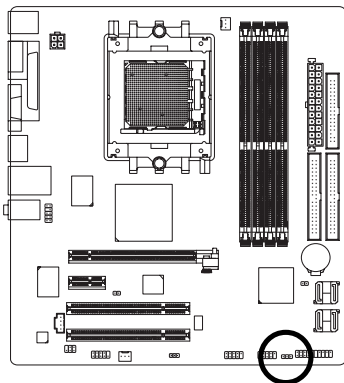

1 

| Pin No. | Definition |
|---------|------------|
| 1 | MPD+ |
| 2 | MPD- |
| 3 | MPD- |

9) BATTERY

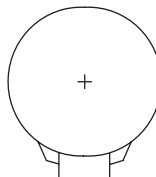
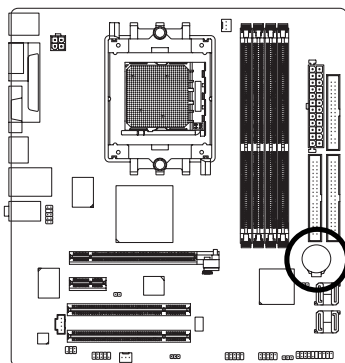

- ❖ Danger of explosion if battery is incorrectly replaced.
- ❖ Replace only with the same or equivalent type recommended by the manufacturer.
- ❖ Dispose of used batteries according to the manufacturer's instructions.

If you want to erase CMOS...

1. Turn off the computer and unplug the power cord.
2. Gently take out the battery and put it aside for about one minute.
(Or you can use a metal object to connect the positive and negative pins in the battery holder to make them short for five seconds.)
3. Re-install the battery.
4. Plug the power cord in and turn on the computer.

10) F_PANEL (Front Panel Jumper)

Please connect the power LED, PC speaker, reset switch and power switch etc. of your chassis front panel to the F_PANEL connector according to the pin assignment below.

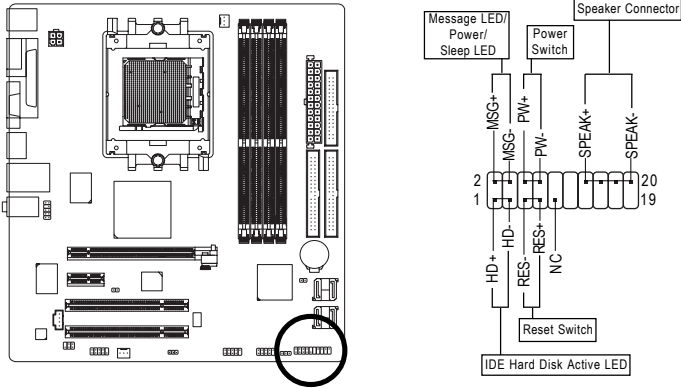

| | |
|-----------------------------------|----------------------------------------------------|
| HD (IDE Hard Disk Active LED) | Pin 1: LED anode(+) Pin 2: LED cathode(-) |
| SPEAK (Speaker Connector) | Pin 1: Power Pin 2- Pin 3: NC Pin 4: Data(-) |
| RES (Reset Switch) | Open: Normal Close: Reset Hardware System |
| PW (Power Switch) | Open: Normal Close: Power On/Off |
| MSG (Message LED/Power/Sleep LED) | Pin 1: LED anode(+) Pin 2: LED cathode(-) |
| NC | NC |

11) F_AUDIO (Front Audio Panel Connector)

This connector supports either HD (High Definition) or AC97 front panel audio module. If you wish to use the front audio function, connect the front panel audio module to this connector. Check the pin assignments carefully while you connect the front panel audio module. Incorrect connection between the module and connector will make the audio device unable to work or even damage it. For optional front panel audio module, please contact your chassis manufacturer.

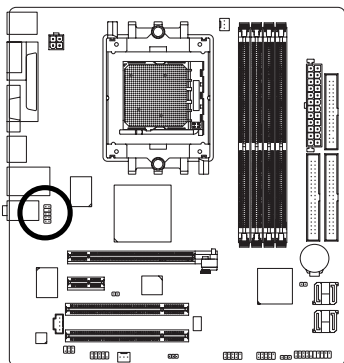

HD Audio:

| Pin No. | Definition |
|---------|------------|
| 1 | MIC2_L |
| 2 | GND |
| 3 | MIC2_R |
| 4 | -ACZ_DET |
| 5 | Line2_R |
| 6 | FSENSE1 |
| 7 | FAUDIO_JD |
| 8 | No Pin |
| 9 | LINE2_L |
| 10 | FSENSE2 |

AC'97 Audio:

| Pin No. | Definition |
|---------|--------------|
| 1 | MIC |
| 2 | GND |
| 3 | MIC Power |
| 4 | NC |
| 5 | Line Out (R) |
| 6 | NC |
| 7 | NC |
| 8 | No Pin |
| 9 | Line Out (L) |
| 10 | NC |



By default, the audio driver is configured to support HD Audio. To connect an AC97 front panel audio module to this connector, please refer to the instructions on Page 85 about the software settings.

12) CD_IN (CD In Connector)

Connect CD-ROM or DVD-ROM audio out to the connector.

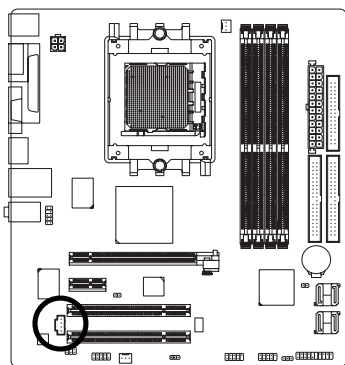

| Pin No. | Definition |
|---------|------------|
| 1 | CD-L |
| 2 | GND |
| 3 | GND |
| 4 | CD-R |

13) F_USB1 / F_USB2 (Front USB Connector)

Be careful with the polarity of the front USB connector. Check the pin assignment carefully while you connect the front USB cable, incorrect connection between the cable and connector will make the device unable to work or even damage it. For optional front USB cable, please contact your local dealer.

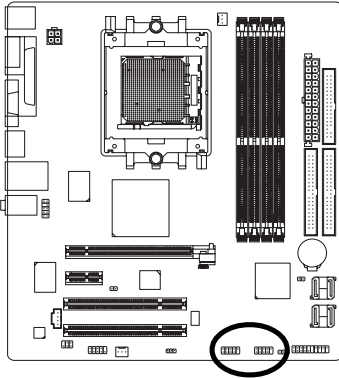

| Pin No. | Definition |
|---------|------------|
| 1 | Power (5V) |
| 2 | Power (5V) |
| 3 | USB DX- |
| 4 | USB Dy- |
| 5 | USB DX+ |
| 6 | USB Dy+ |
| 7 | GND |
| 8 | GND |
| 9 | No Pin |
| 10 | NC |

14) TPM_CLR (TPM_PHYSICAL_PRESENCE)

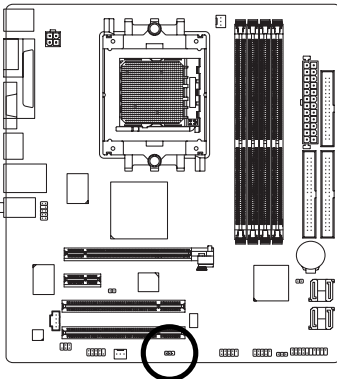

| Pin No. | Definition |
|---------|------------|
| 1 | GND |
| 2 | TPM_PP |
| 3 | VCC3 |

| | |
|-----------|-----------------------------------------------------------------|
| TPM_CLR | Force_Clear command |
| 1-2 short | Support Hardware/Software physical presence function. (Default) |
| 2-3 short | Support Hardware physical presence function. |

15) SPDIF_IO (SPDIF In/Out)

The SPDIF output is capable of providing digital audio to external speakers or compressed AC3 data to an external Dolby Digital Decoder. Use this feature only when your stereo system has digital input function. Use SPDIF IN feature only when your device has digital output function. Be careful with the polarity of the SPDIF_IO connector. Check the pin assignment carefully while you connect the SPDIF cable, incorrect connection between the cable and connector will make the device unable to work or even damage it. For optional SPDIF cable, please contact your local dealer.

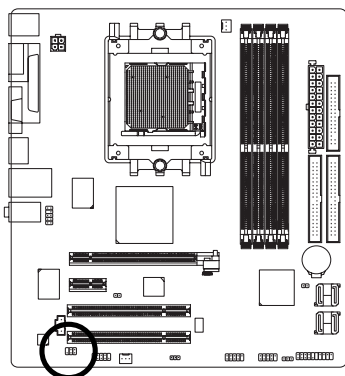

| Pin No. | Definition |
|---------|------------|
| 1 | Power |
| 2 | No Pin |
| 3 | SPDIF |
| 4 | SPDIFI |
| 5 | GND |
| 6 | GND |

16) COMA (COMA Connector)

Be careful with the polarity of the COMA connector. Check the pin assignments while you connect the COMA cable. Please contact your nearest dealer for optional COMA cable.

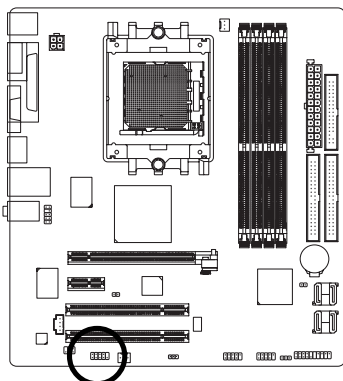

| Pin No. | Definition |
|---------|------------|
| 1 | NCCDA- |
| 2 | NSINA |
| 3 | NSOUTA |
| 4 | NDTRA- |
| 5 | GND |
| 6 | NDSRA- |
| 7 | NRTSA- |
| 8 | NCTSA- |
| 9 | NRIA- |
| 10 | No Pin |

17) CLR_CMOS (Clear CMOS)

You may clear the CMOS data to its default values by this header. To clear CMOS, temporarily short 1-2 pin. Default doesn't include the jumper to avoid improper use of this header.

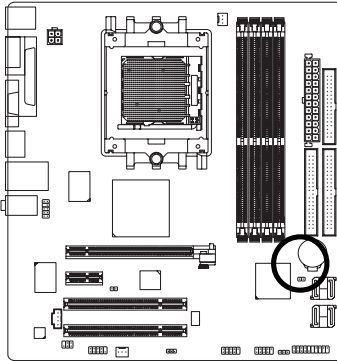

1  Open: Normal

1  Short: Clear CMOS

18) CI (Chassis Intrusion, Case Open)

This 2-pin connector allows your system to detect if the chassis cover is removed. You can check the "Case Open" status in BIOS Setup.

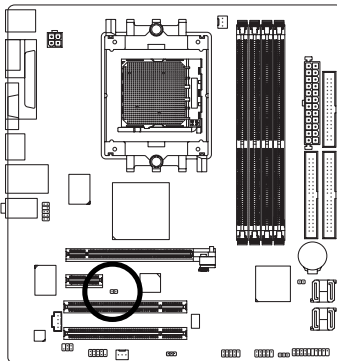

1 

| Pin No. | Definition |
|---------|------------|
| 1 | Signal |
| 2 | GND |

Chapter 2 BIOS Setup

BIOS (Basic Input and Output System) includes a CMOS SETUP utility which allows user to configure required settings or to activate certain system features.

The CMOS SETUP saves the configuration in the CMOS SRAM of the motherboard.

When the power is turned off, the battery on the motherboard supplies the necessary power to the CMOS SRAM.

When the power is turned on, pressing the button during the BIOS POST (Power-On Self Test) will take you to the CMOS SETUP screen. You can enter the BIOS setup screen by pressing "Ctrl + F1".

If you wish to upgrade to a new BIOS, either Gigabyte's Q-Flash or @BIOS utility can be used.

Q-Flash allows the user to quickly and easily update or backup BIOS without entering the operating system.

@BIOS is a Windows-based utility that does not require users to boot to DOS before upgrading BIOS but directly download and update BIOS from the Internet.

CONTROL KEYS

| | |
|-------------------------|-----------------------------------------------------------------------------------------------------------------------------------------------|
| < ↑ > < ↓ > < ← > < → > | Move to select item |
| <Enter> | Select Item |
| <Esc> | Main Menu - Quit and not save changes into CMOS Status Page Setup Menu and Option Page Setup Menu - Exit current page and return to Main Menu |
| <Page Up> | Increase the numeric value or make changes |
| <Page Down> | Decrease the numeric value or make changes |
| <F1> | General help, only for Status Page Setup Menu and Option Page Setup Menu |
| <F2> | Item Help |
| <F5> | Restore the previous CMOS value from CMOS, only for Option Page Setup Menu |
| <F6> | Load the fail-safe default CMOS value from BIOS default table |
| <F7> | Load the Optimized Defaults |
| <F8> | Q-Flash utility |
| <F9> | System Information |
| <F10> | Save all the CMOS changes, only for Main Menu |

Main Menu

The on-line description of the highlighted setup function is displayed at the bottom of the screen.

Status Page Setup Menu / Option Page Setup Menu

Press <F1> to pop up a small help window that describes the appropriate keys to use and the possible selections for the highlighted item. To exit the Help Window press <Esc>.



Because BIOS flashing is potentially risky, please do it with caution and avoid inadequate operation that may result in system malfunction.

<F12> : Boot Menu

Select boot sequence for onboard (or add-on cards) device.

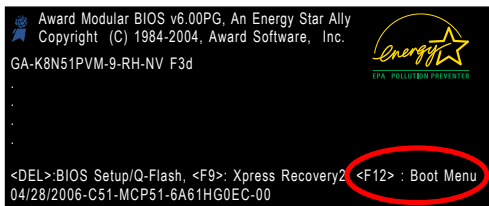

<F12> Boot Menu

Use <↑> or <↓> to select a device, then press enter to accept . Press <ESC> to exit this menu.

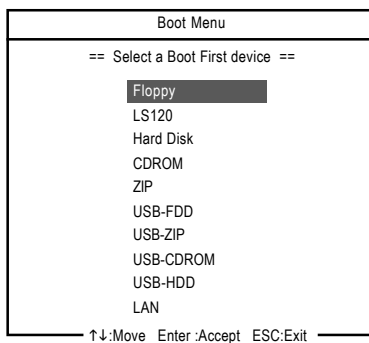

The Main Menu (For example: BIOS Ver. : F3d)

Once you enter Award BIOS CMOS Setup Utility, the Main Menu (as figure below) will appear on the screen. Use arrow keys to select among the items and press <Enter> to accept or enter the sub-menu.

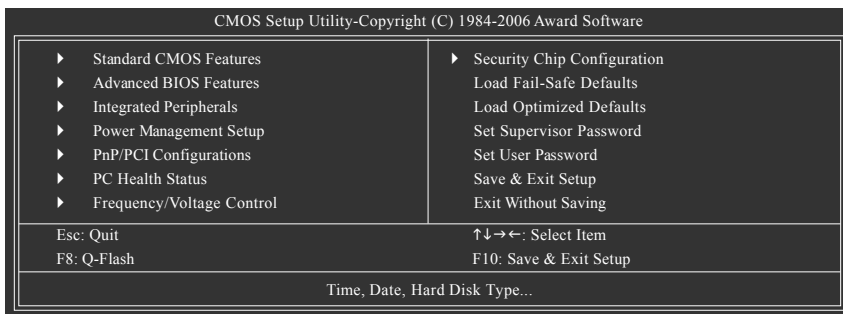

NOTE

If you can't find the setting you want, please press "Ctrl+F1" to search the advanced option hidden.

Please Load Optimized Defaults in the BIOS when somehow the system works not stable as usual. This action makes the system reset to the default for stability.

The BIOS Setup menus described in this chapter are for reference only and may differ from the exact settings for your motherboard.

■ Standard CMOS Features

This setup page includes all the items in standard compatible BIOS.

■ Advanced BIOS Features

This setup page includes all the items of Award special enhanced features.

■ Integrated Peripherals

This setup page includes all onboard peripherals.

■ Power Management Setup

This setup page includes all the items of Green function features.

■ PnP/PCI Configuration

This setup page includes all the configurations of PCI & PnP ISA resources.

■ PC Health Status

This setup page is about system autodetect temperature, voltage, fan speed, etc.

■ Frequency/Voltage Control

This setup page is to control CPU clock and frequency ratio.

■ Load Fail-Safe Defaults

Fail-Safe Defaults indicates the value of the system parameters which the system would be in safe configuration.

■ Load Optimized Defaults

Optimized Defaults indicates the value of the system parameters which the system would be in best performance configuration.

■ Security Chip Configuration

For TPM module function setting.

■ Set Supervisor Password

Change, set, or disable password. It allows you to limit access to the system and Setup, or just to Setup.

■ Set User Password

Change, set, or disable password. It allows you to limit access to the system.

■ Save & Exit Setup

Save CMOS value settings to CMOS and exit setup.

■ Exit Without Saving

Abandon all CMOS value changes and exit setup.

2-1 Standard CMOS Features

| CMOS Setup Utility-Copyright (C) 1984-2006 Award Software Standard CMOS Features | | |
|-------------------------------------------------------------------------------------|---------------------|----------------------------------------------------|
| Date (mm:dd:yy) | Fri, Jun 23 2006 | Item Help |
| Time (hh:mm:ss) | 22:31:24 | Menu Level▶ |
| ▶ IDE Channel 0 Master | [None] | Change the day, month, year |
| ▶ IDE Channel 0 Slave | [None] | |
| ▶ IDE Channel 1 Master | [None] | <Week> Sun. to Sat. |
| ▶ IDE Channel 1 Slave | [None] | |
| ▶ IDE Channel 2 Master | [None] | <Month> Jan. to Dec. |
| ▶ IDE Channel 3 Master | [None] | |
| ▶ IDE Channel 4 Master | [None] | <Day> 1 to 31 (or maximum allowed in the month) |
| ▶ IDE Channel 5 Master | [None] | |
| Drive A | [1.44M, 3.5"] | <Year> 1999 to 2098 |
| Floppy 3 Mode Support | [Disabled] | |
| Halt On | [All, But Keyboard] | |
| Base Memory | 640K | |
| Extended Memory | 511M | |
| Total Memory | 512M | |

↑↓←→: Move Enter: Select +/-/PU/PD: Value F10: Save ESC: Exit F1: General Help
 F5: Previous Values F6: Fail-Safe Defaults F7: Optimized Defaults

☞ Date

The date format is <week>, <month>, <day>, <year>.

- ▶▶ Week The week, from Sun to Sat, determined by the BIOS and is display only
- ▶▶ Month The month, Jan. Through Dec.
- ▶▶ Day The day, from 1 to 31 (or the maximum allowed in the month)
- ▶▶ Year The year, from 1999 through 2098

☞ Time

The times format in <hour> <minute> <second>. The time is calculated based on the 24-hour military-time clock. For example, 1 p.m. is 13:00:00.

☞ IDE Channel 0 Master/Slave; IDE Channel 1 Master/Slave

- ▶▶ IDE HDD Auto-Detection Press "Enter" to select this option for automatic device detection.
- ▶▶ IDE Channel 0 Master/Slave; IDE Channel 1 Master/Slave devices setup. You can use one of three methods:
 - Auto Allows BIOS to automatically detect IDE/SATA devices during POST. (Default value)
 - None Select this if no IDE/SATA devices are used and the system will skip the automatic detection step and allow for faster system start up.
 - Manual User can manually input the correct settings.
- ▶▶ Access Mode Use this to set the access mode for the hard drive. The four options are: CHS/LBA/Large/Auto(default:Auto)

☞ IDE Channel 2/3/4/5 Master

- ▶▶ IDE HDD Auto-Detection Press "Enter" to select this option for automatic device detection.
- ▶▶ Extended IDE Drive You can use one of the two methods:
 - Auto Allows BIOS to automatically detect IDE/SATA devices during POST(default)
 - None Select this if no IDE/SATA devices are used and the system will skip the automatic detection step and allow for faster system start up.

- » Access Mode Use this to set the access mode for the hard drive. The two options are: Large/Auto(default:Auto)
 - » Capacity Capacity of currently installed hard drive.
- Hard drive information should be labeled on the outside drive casing. Enter the appropriate option based on this information.
- » Cylinder Number of cylinders
 - » Head Number of heads
 - » Precomp Write precomp
 - » Landing Zone Landing zone
 - » Sector Number of sectors

☞ Drive A

The category identifies the types of floppy disk drive A that has been installed in the computer.

- » None No floppy drive installed.
- » 360K, 5.25" 5.25 inch PC-type standard drive; 360K byte capacity.
- » 1.2M, 5.25" 5.25 inch AT-type high-density drive; 1.2M byte capacity.
(3.5 inch when 3 Mode is Enabled).
- » 720K, 3.5" 3.5 inch double-sided drive; 720K byte capacity
- » 1.44M, 3.5" 3.5 inch double-sided drive; 1.44M byte capacity.
- » 2.88M, 3.5" 3.5 inch double-sided drive; 2.88M byte capacity.

☞ Floppy 3 Mode Support (for Japan Area)

- » Disabled Normal Floppy Drive. (Default value)
- » Drive A Drive A is 3 mode Floppy Drive.

☞ Halt on

The category determines whether the computer will stop if an error is detected during power up.

- » No Errors The system boot will not stop for any error that may be detected and you will be prompted.
- » All Errors Whenever the BIOS detects a non-fatal error the system will be stopped.
- » All, But Keyboard The system boot will not stop for a keyboard error; it will stop for all other errors. (Default value)
- » All, But Diskette The system boot will not stop for a disk error; it will stop for all other errors.
- » All, But Disk/Key The system boot will not stop for a keyboard or disk error; it will stop for all other errors.

☞ Memory

The category is display-only which is determined by POST (Power On Self Test) of the BIOS.

» Base Memory

The POST of the BIOS will determine the amount of base (or conventional) memory installed in the system.

The value of the base memory is typically 512K for systems with 512K memory installed on the motherboard, or 640K for systems with 640K or more memory installed on the motherboard.

» Extended Memory

The BIOS determines how much extended memory is present during the POST.

This is the amount of memory located above 1 MB in the CPU's memory address map.

» Total Memory

This item displays the memory size that used.

2-2 Advanced BIOS Features

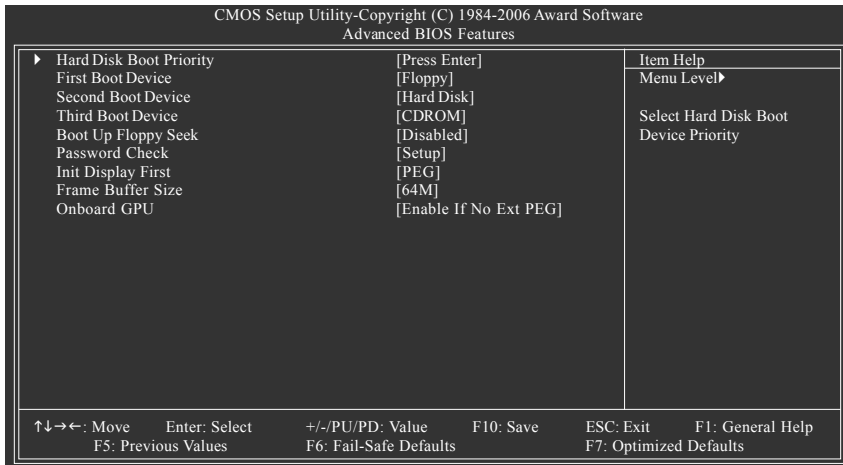

☞ Hard Disk Boot Priority

Select boot sequence for onboard(or add-on cards) SCSI, RAID, etc.

Use <↑> or <↓> to select a device, then press<+> to move it up, or <-> to move it down the list. Press <ESC> to exit this menu.

☞ First / Second / Third Boot Device

- ▶ Floppy Select your boot device priority by Floppy.
- ▶ LS120 Select your boot device priority by LS120.
- ▶ Hard Disk Select your boot device priority by Hard Disk.
- ▶ CDROM Select your boot device priority by CDROM.
- ▶ ZIP Select your boot device priority by ZIP.
- ▶ USB-FDD Select your boot device priority by USB-FDD.
- ▶ USB-ZIP Select your boot device priority by USB-ZIP.
- ▶ USB-CDROM Select your boot device priority by USB-CDROM.
- ▶ USB-HDD Select your boot device priority by USB-HDD.
- ▶ Legacy LAN Select your boot device priority by LAN.
- ▶ Disabled Disable this function.

☞ Boot Up Floppy Seek

During POST, BIOS will determine the floppy disk drive installed is 40 or 80 tracks. 360K type is 40 tracks 720K, 1.2M and 1.44M are all 80 tracks.

- ▶ Enabled BIOS searches for floppy disk drive to determine it is 40 or 80 tracks. Note that BIOS can not tell from 720K, 1.2M or 1.44M drive type as they are all 80 tracks.
- ▶ Disabled BIOS will not search for the type of floppy disk drive by track number. Note that there will not be any warning message if the drive installed is 360K. (Default value)

🔑 Password Check

- ▶▶ System The system can not boot and can not access to Setup page will be denied if the correct password is not entered at the prompt.
- ▶▶ Setup The system will boot, but access to Setup will be denied if the correct password is not entered at the prompt. (Default value)

🔑 Init Display First

This feature allows you to select the first initiation of the monitor display from which card when you install a PCI card and a PCI Express VGA card on the motherboard.

- ▶▶ PCI Slot Set Init Display First to PCI VGA card.
- ▶▶ Onboard VGA Set Init Display First to onboard VGA.
- ▶▶ PEG Set Init Display First to PCI Express VGA card. (Default value)

🔑 Frame Buffer Size

- ▶▶ 16M Set frame buffer size to 16MB.
- ▶▶ 32M Set frame buffer size to 32MB.
- ▶▶ 64M Set frame buffer size to 64MB. (Default value)
- ▶▶ 128M Set frame buffer size to 128MB.
- ▶▶ Disabled Disable this function.

🔑 Onboard GPU

- ▶▶ Enable If No Ext PEG Onboard GPU will be disabled if there is a graphics card on the PCI Express slot. (Default value)
- ▶▶ Always Enable Onboard GPU will always be enabled whether there is a graphics card on the PCI Express slot or not.

2-3 Integrated Peripherals

| CMOS Setup Utility-Copyright (C) 1984-2006 Award Software Integrated Peripherals | | |
|--------------------------------------------------------------------------------------------------------------------------------------------------------------------------|---------------|-------------|
| ▶ SATAII RAID Config | [Press Enter] | Item Help |
| On-Chip IDE Channel0 | [Enabled] | Menu Level▶ |
| On-Chip IDE Channel1 | [Enabled] | |
| IDE1 Conductor Cable | [Auto] | |
| IDE2 Conductor Cable | [Auto] | |
| Serial-ATAII 1 | [Enabled] | |
| Serial-ATAII 2 | [Enabled] | |
| On-Chip USB | [V1.1+V2.0] | |
| USB Keyboard Support | [Disabled] | |
| USB Mouse Support | [Disabled] | |
| Onboard Audio Function | [Auto] | |
| Onboard LAN Function | [Auto] | |
| Onboard LAN Boot ROM | [Disabled] | |
| Legacy USB storage detect | [Enabled] | |
| Onboard Serial Port 1 | [3F8/IRQ4] | |
| Onboard Parallel Port | [378/IRQ7] | |
| Parallel Port Mode | [SPP] | |
| ↑↓←→: Move Enter: Select +/-/PU/PD: Value F10: Save ESC: Exit F1: General Help F5: Previous Values F6: Fail-Safe Defaults F7: Optimized Defaults | | |

☞ SATAII RAID Config

| CMOS Setup Utility-Copyright (C) 1984-2006 Award Software SATAII RAID Config | | |
|--------------------------------------------------------------------------------------------------------------------------------------------------------------------------|------------|-------------|
| SATA-II RAID function | [Disabled] | Item Help |
| x SATA-II 1 Primary RAID | Disabled | Menu Level▶ |
| x SATA-II 1 Secondary RAID | Disabled | |
| x SATA-II 2 Primary RAID | Disabled | |
| x SATA-II 2 Secondary RAID | Disabled | |
| ↑↓←→: Move Enter: Select +/-/PU/PD: Value F10: Save ESC: Exit F1: General Help F5: Previous Values F6: Fail-Safe Defaults F7: Optimized Defaults | | |

☞ SATA-II RAID function

- ▶ Enabled Enable SATAII RAID function.
- ▶ Disabled Disable SATAII RAID function. (Default value)

☞ SATA-II 1 Primary RAID

- ▶ Enabled Enable SATAII 1 1st SATA RAID function.
- ▶ Disabled Disable this function. (Default value)

☞ SATA-II 1 Secondary RAID

- ▶ Enabled Enable SATAII 1 2nd SATA RAID function.
- ▶ Disabled Disable this function. (Default value)

☞ SATA-II 2 Primary RAID

- ▶▶ **Enabled** **Enable SATAII 2 1st SATA RAID function.**
- ▶▶ Disabled Disable this function. (Default value)

☞ SATA-II 2 Secondary RAID

- ▶▶ Enabled Enable SATAII 2 2nd SATA RAID function.
- ▶▶ Disabled Disable this function. (Default value)

☞ On-Chip IDE Channel0

- ▶▶ Enabled Enable onboard 1st channel IDE port. (Default value)
- ▶▶ Disabled Disable onboard 1st channel IDE port.

☞ On-Chip IDE Channel1

- ▶▶ Enabled Enable onboard 2nd channel IDE port. (Default value)
- ▶▶ Disabled Disable onboard 2nd channel IDE port.

☞ IDE1 Conductor Cable

- ▶▶ Auto BIOS autodetects IDE1 conductor cable. (Default Value)
- ▶▶ ATA66/100/133 Set IDE1 Conductor Cable to ATA66/100/133 (Please make sure your IDE device and cable are compatible with ATA66/100/133).
- ▶▶ ATA33 Set IDE1 Conductor Cable to ATA33. (Please make sure your IDE device and cable are compatible with ATA33)

☞ IDE2 Conductor Cable

- ▶▶ Auto BIOS autodetects IDE2 conductor cable. (Default Value)
- ▶▶ ATA66/100/133 Set IDE2 Conductor Cable to ATA66/100/133. (Please make sure your IDE device and cable are compatible with ATA66/100/133)
- ▶▶ ATA33 Set IDE2 Conductor Cable to ATA33. (Please make sure your IDE device and cable are compatible with ATA33)

☞ Serial-ATAII 1

- ▶▶ Enabled Enable Serial-ATAII 1 support. (Default Value)
- ▶▶ Disabled Disable Serial-ATAII 1 support.

☞ Serial-ATAII 2

- ▶▶ Enabled Enable Serial-ATAII 2 support. (Default Value)
- ▶▶ Disabled Disable Serial-ATAII 2 support.

☞ On-Chip USB

- ▶▶ V1.1+V2.0 Enable USB 1.1 and USB 2.0 controllers. (Default Value)
- ▶▶ V1.1 Enable only USB 1.1 controller
- ▶▶ Disabled Disable onchip USB support.

☞ USB Keyboard Support

- ▶▶ Enabled Enable USB keyboard support.
- ▶▶ Disabled Disable USB keyboard support. (Default value)

☞ USB Mouse Support

- ▶▶ Enabled Enable USB mouse support.
- ▶▶ Disabled Disable USB mouse support. (Default value)

☞ Onboard Audio Function

- ▶▶ Auto Auto-detect onboard audio function. (Default value)
- ▶▶ Disabled Disable this function.

☞ Onboard LAN Function

- ▶▶ Auto Auto-detect onboard LAN chip function.(Default value)
- ▶▶ Disabled Disable onboard LAN chip function.

☞ Onboard LAN Boot ROM

This function decide whether to invoke the boot ROM of the onboard LAN chip.

- ▶▶ Enabled Enable this function.
- ▶▶ Disabled Disable this function. (Default value)

☞ Legacy USB storage detect

This option allows users to decide whether to detect USB storage devices, including USB flash drives and USB hard drives during POST.

- ▶▶ Enabled BIOS will scan all USB storage devices. (Default value)
- ▶▶ Disabled Disable this function.

☞ Onboard Serial Port 1

- ▶▶ Auto BIOS will automatically setup the port 1 address.
- ▶▶ 3F8/IRQ4 Enable onboard Serial port 1 and address is 3F8/IRQ4. (Default value)
- ▶▶ 2F8/IRQ3 Enable onboard Serial port 1 and address is 2F8/IRQ3.
- ▶▶ 3E8/IRQ4 Enable onboard Serial port 1 and address is 3E8/IRQ4.
- ▶▶ 2E8/IRQ3 Enable onboard Serial port 1 and address is 2E8/IRQ3.
- ▶▶ Disabled Disable onboard Serial port 1.

☞ Onboard Parallel Port

- ▶▶ Disabled Disable onboard LPT port.
- ▶▶ 378/IRQ7 Enable onboard LPT port and address is 378/IRQ7. (Default value)
- ▶▶ 278/IRQ5 Enable onboard LPT port and address is 278/IRQ5.
- ▶▶ 3BC/IRQ7 Enable onboard LPT port and address is 3BC/IRQ7.

☞ Parallel Port Mode

- ▶▶ SPP Using Parallel port as Standard Parallel Port. (Default value)
- ▶▶ EPP Using Parallel port as Enhanced Parallel Port.
- ▶▶ ECP Using Parallel port as Extended Capabilities Port.
- ▶▶ ECP+EPP Using Parallel port as ECP and EPP mode.

2-4 Power Management Setup

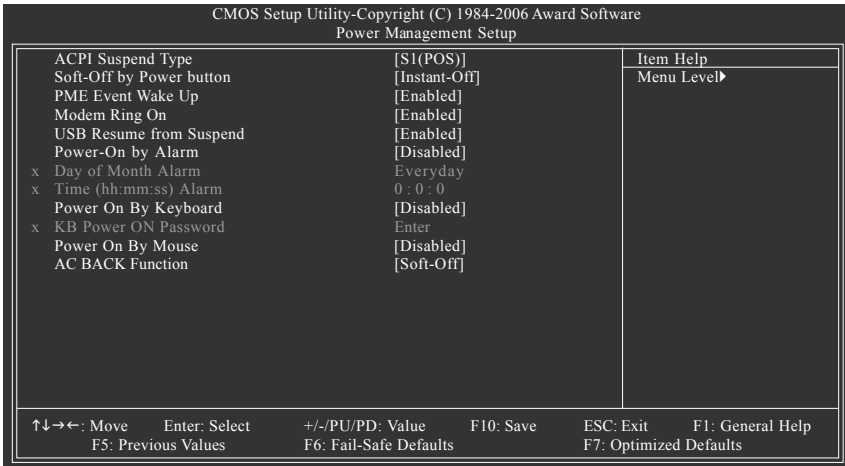

☞ ACPI Suspend Type

- ▶▶ S1(POS) Set ACPI suspend type to S1/POS(Power On Suspend). (Default value)
- ▶▶ S3(STR) Set ACPI suspend type to S3/STR(Suspend To RAM).

☞ Soft-Off by Power button

- ▶▶ Instant-Off Press power button then Power off instantly. (Default value)
- ▶▶ Delay 4 Sec. Press power button 4 sec. to Power off. Enter suspend if button is pressed less than 4 sec.

☞ PME Event Wake Up

This feature requires an ATX power supply that provides at least 1A on the 5VSB lead.

- ▶▶ Disabled Disable this function.
- ▶▶ Enabled Enable PME as wake up event. (Default value)

☞ Modem Ring On

An incoming call via modem can awake the system from any suspend state.

- ▶▶ Disabled Disable this function.
- ▶▶ Enabled Enable Modem Ring On function. (Default value)

☞ USB Resume from Suspend

- ▶▶ Disabled Disable this function.
- ▶▶ Enable Enable USB device wake up system from suspend mode. (Default value)

☞ Power-On by Alarm

You can set "Power-On by Alarm" item to enabled and key in Date/Time to power on system.

- ▶▶ Disabled Disable this function. (Default value)
- ▶▶ Enabled Enable alarm function to POWER ON system.

If Power-On by Alarm is Enabled.

- ▶▶ Day of Month Alarm : Everyday, 1~31
- ▶▶ Time (hh: mm: ss) Alarm : (0~23) : (0~59) : (0~59)

☞ **Power On By Keyboard**

- ▶▶ Disabled Disabled this function. (Default value)
- ▶▶ Keyboard 98 If your keyboard have "POWER Key" button, you can press the key to power on the system.
- ▶▶ Any KEY Press any keys on your keyboard to power on the system.
- ▶▶ Password Enter from 1 to 5 characters to set the Keyboard Power On Password.

☞ **KB Power ON Password**

When "Power On by Keyboard" is set to Password, you can set the password here.

- ▶▶ Enter Input password (from 1 to 5 characters) and press Enter to set the Keyboard Power On password.

☞ **Power On By Mouse**

- ▶▶ Disabled Disabled this function. (Default value)
- ▶▶ Enable Double click on PS/2 mouse left button to power on the system.

☞ **AC BACK Function**

- ▶▶ Soft-Off When AC-power back to the system, the system will be in "Off" state. (Default value)
- ▶▶ Full-On When AC-power back to the system, the system always in "On" state.
- ▶▶ Memory When AC-power back to the system, the system will return to the Last state before AC-power off.

2-5 PnP/PCI Configurations

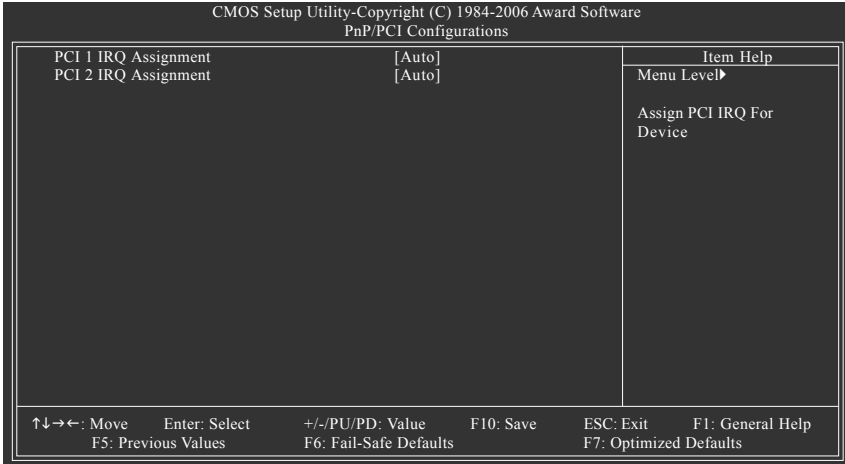

☞ PCI 1 IRQ Assignment

- ▶▶ Auto Auto assign IRQ to PCI 1. (Default value)
- ▶▶ 3,4,5,7,9,10,11,12,14,15 Set IRQ 3,4,5,7,9,10,11,12,14,15 to PCI 1.

☞ PCI 2 IRQ Assignment

- ▶▶ Auto Auto assign IRQ to PCI 2. (Default value)
- ▶▶ 3,4,5,7,9,10,11,12,14,15 Set IRQ 3,4,5,7,9,10,11,12,14,15 to PCI 2.

2-6 PC Health Status

| CMOS Setup Utility-Copyright (C) 1984-2006 Award Software | |
|-----------------------------------------------------------|-------------------------------------------------------------------------|
| PC Health Status | |
| | Item Help |
| Reset Case Open Status | [Disabled] |
| Case Opened | Yes |
| VCORE | OK |
| DDR Power | OK |
| +3.3V | OK |
| +12V | OK |
| System Temperature | 32°C/89°F |
| CPU Temperature | 45°C/113°F |
| System FAN Speed | 3245 RPM |
| CPU FAN Speed | 3245 RPM |
| CPU Warning Temp. | [Disabled] |
| System FAN Stop Warning | [Disabled] |
| CPU FAN Stop Warning | [Disabled] |
| CPU Smart FAN Control | [Disabled] |
| System Smart FAN Control | [Disabled] |
| | [Disabled] Don't reset case open status |
| | [Enabled] Clear case open status and set to be Disabled at next boot |
| ↑↓←→: Move | Enter: Select |
| F5: Previous Values | +/-/PU/PD: Value |
| | F6: Fail-Safe Defaults |
| | F10: Save |
| | ESC: Exit |
| | F1: General Help |
| | F7: Optimized Defaults |

☞ Reset Case Open Status

- ▶▶ Disabled Don't reset case open status. (Default value)
- ▶▶ Enabled Clear case open status at next boot.

☞ Case Opened

If the case is closed, **Case Opened** will show "No."

If the case is opened, **Case Opened** will show "Yes."

If you want to reset **Case Opened** value, enable **Reset Case Open Status** and save the change to CMOS, and then your computer will restart.

☞ Current Voltage(V) VCORE / DDR Power / +3.3V / +12V

- ▶▶ Detect system's voltage status automatically.

☞ System/CPU Temperature

- ▶▶ Detect system/CPU temperature automatically.

☞ System/CPU FAN Speed (RPM)

- ▶▶ Detect System/CPU fan speed status automatically.

☞ CPU Warning Temp.

- ▶▶ 60°C / 140°F Monitor CPU temperature at 60°C / 140°F.
- ▶▶ 70°C / 158°F Monitor CPU temperature at 70°C / 158°F.
- ▶▶ 80°C / 176°F Monitor CPU temperature at 80°C / 176°F.
- ▶▶ 90°C / 194°F Monitor CPU temperature at 90°C / 194°F.
- ▶▶ Disabled Disable this function. (Default value)

☞ System/CPU FAN Stop Warning

- ▶▶ Disabled Disable System/CPU fan stop warning function. (Default value)
- ▶▶ Enabled Enable System/CPU fan stop warning function.

☞ **CPU Smart FAN Control** ^(Note)

- ▶▶ Disabled Disable this function. (Default value)
- ▶▶ Enabled When this function is enabled, CPU fan will run at different speed depending on CPU temperature. Users can adjust the fan speed with Easy Tune based on their requirements.

☞ **System Smart FAN Control**

- ▶▶ Disabled Disable this function. (Default value)
- ▶▶ Enabled When this function is enabled, System fan will run at different speed depending on System temperature.

(Note) Whether the CPU Smart FAN Control function is supported will depend on the CPU you install. For more detailed information please check at the FAQ section on GIGABYTE's website.

2-7 Frequency/Voltage Control

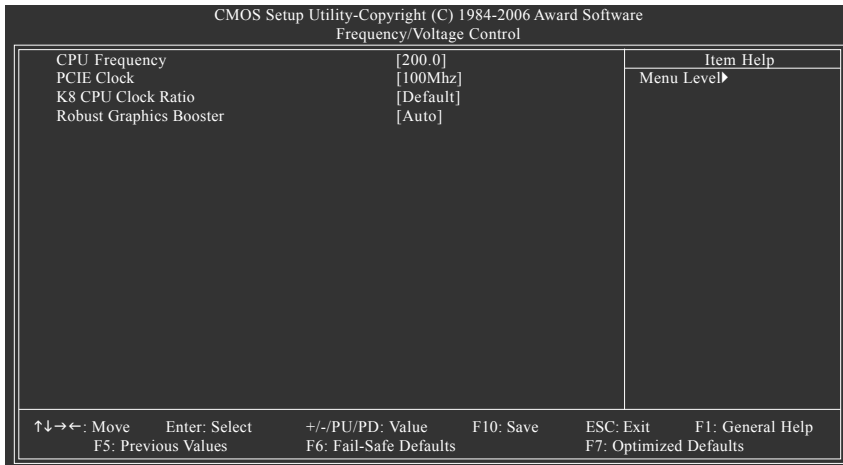

Incorrectly using these features may result in system instability or corruption.

Doing a overclock or overvoltage on CPU, chipsets and memory modules may result in damages or shortened life expectancy to these components.

Please be aware that the menu items are for power users only.

☞ CPU Frequency

▶▶ 200.0~300.0MHz Set CPU Frequency from 200MHz to 300MHz.

☞ PCIE Clock

▶▶ 100~145MHz Set PCIe Clock from 100MHz to 145MHz.

☞ K8 CPU Clock Ratio

This setup option will automatically assign by CPU detection. The option will display "Locked" and read only or will not show up if the CPU ratio is not changeable.

☞ Robust Graphics Booster

Select the options can enhance the VGA graphics card bandwidth to get higher performance.

▶▶ Auto Set Robust Graphics Booster to Auto. (Default value)

▶▶ Fast Set Robust Graphics Booster to Fast.

▶▶ Turbo Set Robust Graphics Booster to Turbo.

2-8 Security Chip Configuration

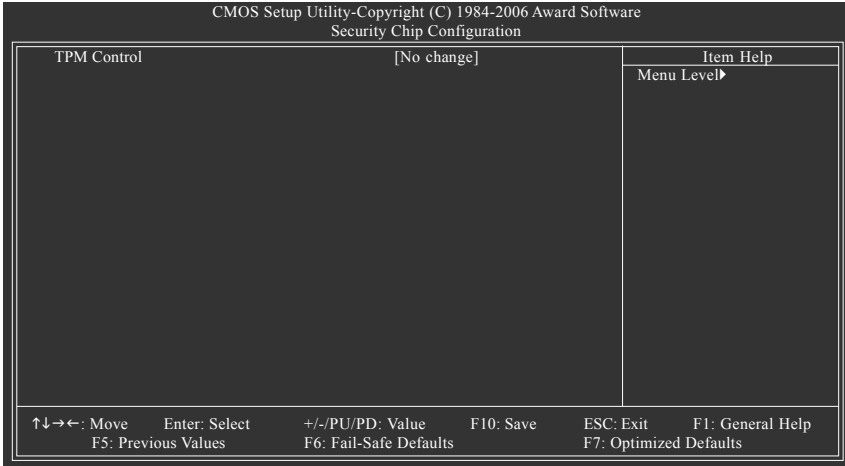

☞ TPM Control (Trusted Platform Module Control)

- | | |
|------------------------|--------------------------------------------------------------|
| ▶▶ No change | No changes will be made.(Default value) |
| ▶▶ Enabled | Enabled TPM control function. |
| ▶▶ Disabled | Disabled TPM control function. |
| ▶▶ Enabled+Clear Owner | Clear TPM internal policy, and enabled TPM control function. |

2-9 Load Fail-Safe Defaults

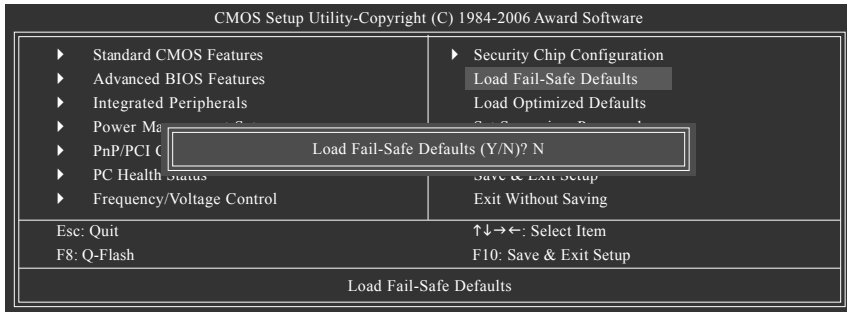

Fail-Safe defaults contain the most appropriate values of the system parameters that allow minimum system performance.

2-10 Load Optimized Defaults

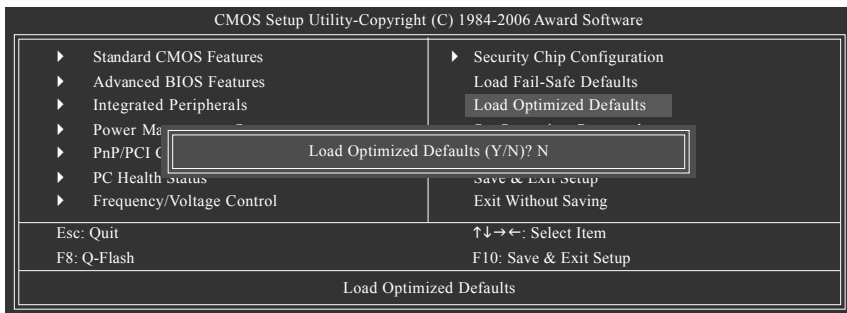

Selecting this field loads the factory defaults for BIOS and Chipset Features which the system automatically detects.

2-11 Set Supervisor/User Password

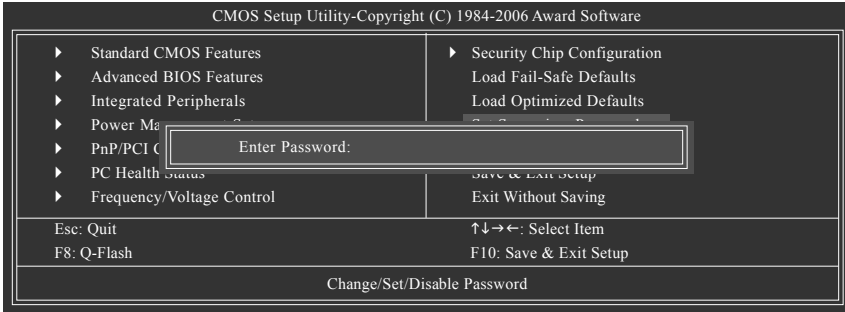

When you select this function, the following message will appear at the center of the screen to assist you in creating a password.

Type the password, up to eight characters, and press <Enter>. You will be asked to confirm the password. Type the password again and press <Enter>. You may also press <Esc> to abort the selection and not enter a password.

To disable password, just press <Enter> when you are prompted to enter password. A message "PASSWORD DISABLED" will appear to confirm the password being disabled. Once the password is disabled, the system will boot and you can enter Setup freely.

The BIOS Setup program allows you to specify two separate passwords:

SUPERVISOR PASSWORD and a USER PASSWORD. When disabled, anyone may access all BIOS Setup program function. When enabled, the Supervisor password is required for entering the BIOS Setup program and having full configuration fields, the User password is required to access only basic items.

If you select "System" at "Password Check" in Advance BIOS Features Menu, you will be prompted for the password every time the system is rebooted or any time you try to enter Setup Menu.

If you select "Setup" at "Password Check" in Advance BIOS Features Menu, you will be prompted only when you try to enter Setup.

2-12 Save & Exit Setup

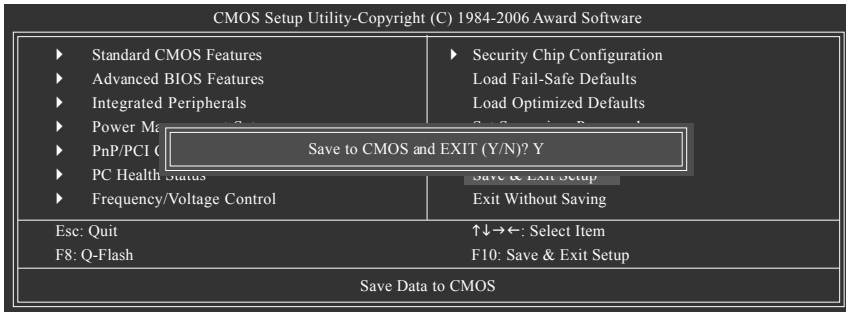

Type "Y" will quit the Setup Utility and save the user setup value to RTC CMOS.
Type "N" will return to Setup Utility.

2-13 Exit Without Saving

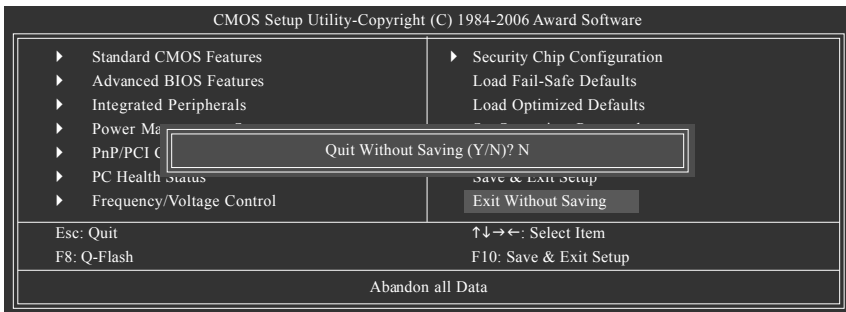

Type "Y" will quit the Setup Utility without saving to RTC CMOS.
Type "N" will return to Setup Utility.

Chapter 3 Drivers Installation



Pictures below are shown in Windows XP.

Insert the driver CD-title that came with your motherboard into your CD-ROM drive, the driver CD-title will auto start and show the installation guide. If not, please double click the CD-ROM device icon in "My computer", and execute the Setup.exe.

3-1 Install Chipset Drivers

After insert the driver CD, "Xpress Install" will scan automatically the system and then list all the drivers that recommended to install. The "Xpress Install" uses the "Click and Go" technology to install the drivers automatically. Just select the drivers you want then click the "GO" button. The "Xpress Install" will execute the installation for you automatically.

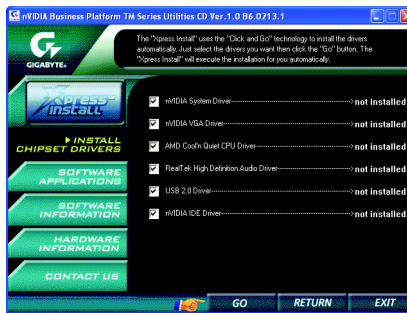

Some device drivers will restart your system automatically. After restarting your system the "Xpress Install" will continue to install other drivers.

System will reboot automatically after install the drivers, afterward you can install others application.



For USB2.0 driver support under Windows XP operating system, please use Windows Service Pack. After install Windows Service Pack, it will show a question mark "?" in "Universal Serial Bus controller" under "Device Manager". Please remove the question mark and restart the system (System will auto-detect the right USB2.0 driver).

3-2 Software Application

This page displays all the tools that GIGABYTE developed and some free software. You can click an item to install it.



3-3 Software Information

This page lists the contents of software and drivers in this CD-title.

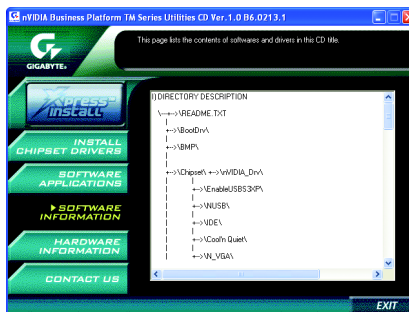

3-4 Hardware Information

This page lists all device you have for this motherboard.

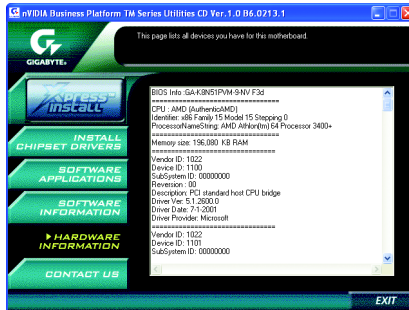

3-5 Contact Us

Please see the last page for details.



3-6 Dual-Monitor Setup

To setup a Dual-Monitor system, you have to prepare one 15-pin VGA monitor and one DVI-D monitor. Then connect the VGA monitor to the VGA port and the digital monitor to the DVI-D port in back panel of the motherboard.

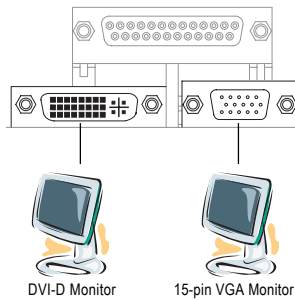

After installation of the drivers, you can set the display to output from two monitors on the **nView Display Settings** page.

To access the **nView Display Settings** page, right-click on Desktop and select **Properties**. Then select the **Settings** tab and click the **Advanced** button.

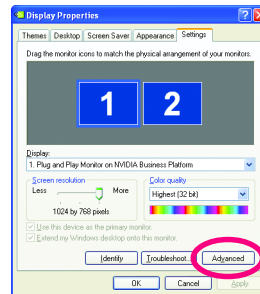

After pressing the **Advanced** button in settings, you'll see the **Plug and Play Monitor and NVIDIA Business Platform** dialog box. Click the **NVIDIA Business Platform** tab. In the left list, click **nView Display Settings**.

In the **nView Display Settings** properties, select the dual-monitor modes from **nView Display Mode**.

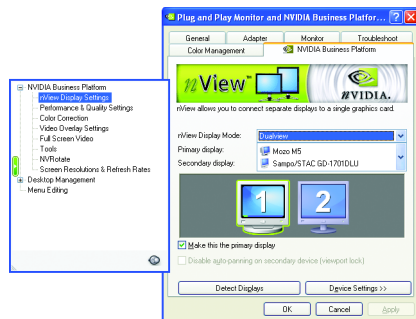

This motherboard supports the following modes:

(1) Clone Mode:

Clone mode indicates that both displays in the display pair show images of the same desktop. Select **Clone** from the **nView Display Mode** list and click **Apply**.



Clone Mode

(2) Horizontal Span Mode:

Horizontal Span mode indicates that both displays in the display pair function as one wide virtual desktop. The width of each display is half the width of the total virtual desktop width. Select **Horizontal Span** from the **nView Display Mode** list and click **Apply**.



Horizontal Span Mode

(3) Vertical Span Mode:

Vertical Span mode indicates that both displays in the display pair function as one tall virtual desktop. The height of each display is half the height of the total virtual desktop height. Select **Vertical Span** from the **nView Display Mode** list and click **Apply**.

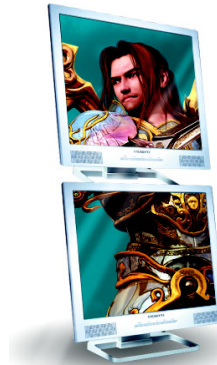

Vertical Span Mode

(4) Dual View Mode:

Dualview mode indicates that both displays in the display pair function as one virtual desktop. Unlike Horizontal Span or Vertical Span mode, Dualview treats each display as a separate device. This means that the taskbar will not be stretched across displays and 3D applications are not accelerated as efficiently as when the application spans displays.

Select **DualView** from the **nView Display Mode** list and click **Apply**.



Dual View Mode

Chapter 4 Appendix

4-1 Unique Software Utilities

4-1-1 EasyTune 5 Introduction

EasyTune 5 presents the most convenient Windows based system performance enhancement and manageability utility. Featuring several powerful yet easy to use tools such as 1) Overclocking for enhancing system performance, 2) C.I.A. and M.I.B. for special enhancement for CPU and Memory, 3) Smart-Fan control for managing fan speed control of both CPU cooling fan and North-Bridge Chipset cooling fan, 4) PC health for monitoring system status.^(Note)

User Interface Overview



| | Button / Display | Description |
|-----|-----------------------------------|-----------------------------------------------|
| 1. | Overclocking | Enters the Overclocking setting page |
| 2. | C.I.A./C.I.A.2 and M.I.B./M.I.B.2 | Enters the C.I.A./2 and M.I.B./2 setting page |
| 3. | Smart-Fan | Enters the Smart-Fan setting page |
| 4. | PC Health | Enters the PC Health setting page |
| 5. | GO | Confirmation and Execution button |
| 6. | "Easy Mode" & "Advance Mode" | Toggles between Easy and Advance Mode |
| 7. | Display screen | Display panel of CPU frequency |
| 8. | Function display LEDs | Shows the current functions status |
| 9. | GIGABYTE Logo | Log on to GIGABYTE website |
| 10. | Help button | Display EasyTune™ 5 Help file |
| 11. | Exit or Minimize button | Quit or Minimize EasyTune™ 5 software |

(Note) EasyTune 5 functions may vary depending on different motherboards.

4-1-2 Xpress Recovery2 Introduction



Xpress Recovery2 is designed to provide quick backup and restoration of hard disk data. Supporting Microsoft operating systems including Windows XP/2000/NT/98/Me and DOS, and file systems including FAT16, FAT32, and NTFS, Xpress Recovery2 is able to back up data on hard disks on PATA and SATA IDE controllers. After Xpress Recovery2 is executed from CD-ROM for the first time, it will stay permanent in your hard disk. If you wish to run Xpress Recovery2 later, you can simply press F9 during system bootup to enter Xpress Recovery2 without the CD-ROM.

System requirements:

1. Intel x86 platforms
2. At least 64M bytes of system memory
3. VESA-supported VGA cards

How to use the Xpress Recovery2

Initial access by booting from CD-ROM and subsequent access by pressing the F9 key:

Steps: After entering BIOS Setup, go to **Advanced BIOS Feature** and set to boot from CD-ROM. Save the settings and exit the BIOS Setup. Insert the provided driver CD into your CD-ROM drive. Upon system restart, the message which says "Boot from CD/DVD:" will appear in the bottom left corner of the screen. Press any key to enter Xpress Recovery2.

After the steps above are completed, subsequent access to Xpress Recovery2 can be made by simply pressing the <F9> key during system power-on.



Boot from CD/DVD:

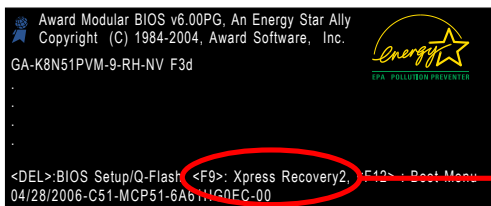

<F9> Xpress Recovery2



1. If you have already entered Xpress Recovery2 by booting from the CD-ROM, you can enter Xpress Recovery2 by pressing the <F9> key in the future.
2. System storage capacity and the reading/writing speed of the hard disk will affect the data backup speed.
3. It is recommended that Xpress Recovery2 be immediately installed once you complete installations of OS and all required drivers as well as software.

The Main Screen of Xpress Recovery2



1. RESTORE:

Restore the backed-up data to your hard disk.
(This button will not appear if there is no backup file.)

2. BACKUP:

Back up data from hard disk.

3. REMOVE:

Remove previously-created backup files to release disk space.

(This button will not appear if there is no backup file.)

4. REBOOT:

Exit the main screen and restart the system.

Limitations:

1. Not compatible to Xpress Recovery.
2. For the use of Xpress Recovery2, a primary partition must be reserved.
3. Xpress Recovery2 will store the backup file at the end of the hard disk, so free space available on the hard disk for the backup file must be allocated in advance. (A minimum 4GB is recommended but the actual space is dependent on the size of the data to be backed up)
4. Capable of backing up hard disks installed with Windows operating systems including DOS and Windows XP/2000/NT/9x/Me.
5. USB hard disks are currently not supported.
6. Does not support RAID/AHCI (class code 0104/0106) hard disks.
7. Capable of backing up and restoring only the first physical hard disk.

Hard disks detection sequence is as follows:

- a. PATA IDE primary channel
- b. PATA IDE secondary channel
- c. SATA IDE channel 1
- d. SATA IDE channel 2
- e. SATA IDE channel 3
- f. SATA IDE channel 4

Precautions:

1. When using hard disks with more than 128G under Windows 2000, be sure to execute the EnableBigLba.exe program from the driver CD before data backup.
2. It is normal that data backup takes longer time than data restoration.
3. Xpress Recovery2 is compliant with the GPL regulations.
4. On a few motherboards based on Nvidia chipsets, BIOS update is required for Xpress Recovery2 to correctly identify RAID and SATA IDE mode. Please contact your motherboard manufacturer.
5. Xpress Recovery2 supports only PATA hard disks and not SATA hard disks on the following motherboards (As this is a BIOS-related issue, it can be solved by BIOS update)

| | | |
|------------------|--------------------------|-----------------|
| GA-K8U | GA-K8NXP-9 | GA-8N-SLI Royal |
| GA-K8U-9 | GA-K8N Ultra-9 | GA-8N-SLI Pro |
| GA-K8NXP-SLI | GA-K8NF-9 (PCB Ver. 1.0) | GA-8N-SLI |
| GA-K8N Ultra-SLI | GA-K8NE (PCB Ver. 1.0) | |
| GA-K8N Pro-SLI | GA-K8NMF-9 | |

4-1-3 Flash BIOS Method Introduction



Method 1 : Q-Flash™ Utility

Q-Flash™ is a BIOS flash utility embedded in Flash ROM. With this utility, users only have to stay in the BIOS menu when they want to update BIOS. Q-Flash™ allows users to flash BIOS without any utility in DOS or Windows. Using Q-Flash™ indicating no more fooling around with any complicated instructions and operating system since it is in the BIOS menu.



Please note that because updating BIOS has potential risk, please do it with caution!! We are sorry that Gigabyte Technology Co., Ltd is not responsible for damages of system because of incorrect manipulation of updating BIOS to avoid any claims from end-users.

Before You Begin:

Before you start updating BIOS with the Q-Flash™ utility, please follow the steps below first.

1. Download the latest BIOS for your motherboard from Gigabyte's website.
2. Extract the BIOS file downloaded and save the BIOS file (the one with model name.Fxx. For example, 8KNXPJ.Fba) to a floppy disk.
3. Reboot your PC and press **Del** to enter BIOS menu.

The BIOS upgrading guides below are separated into two parts.

If your motherboard has dual-BIOS, please refer to **Part One**.

If your motherboard has single-BIOS, please refer to **Part Two**.

Part One:

Updating BIOS with Q-Flash™ Utility on Dual BIOS Motherboards.

Some of Gigabyte motherboards are equipped with dual BIOS. In the BIOS menu of the motherboards supporting Q-Flash and Dual BIOS, the Q-Flash utility and Dual BIOS utility are combined in the same screen. This section only deals with how to use Q-Flash utility.

In the following sections, we take GA-8KNXP Ultra as the example to guide you how to flash BIOS from an older version to the latest version. For example, from Fa3 to Fba.

The BIOS file is Fa3
before updating

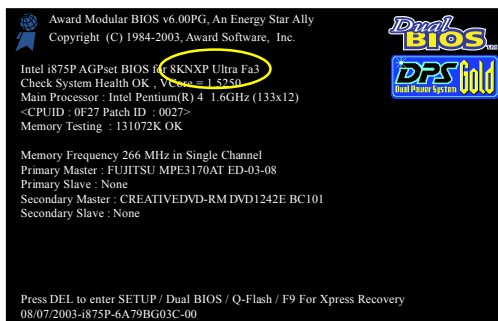

Entering the Q-Flash™ utility:

Step1: To use Q-Flash utility, you must press **Del** in the boot screen to enter BIOS menu.

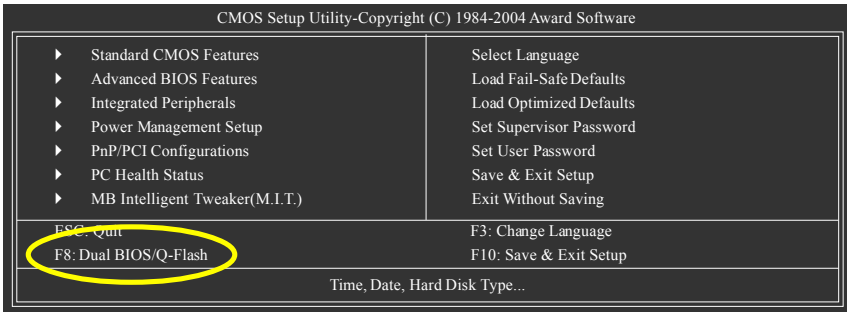

Step 2: Press **F8** button on your keyboard and then **Y** button to enter the Dual BIOS/Q-Flash utility.

Exploring the Q-Flash™ / Dual BIOS utility screen

The Q-Flash / Dual BIOS utility screen consists of the following key components.

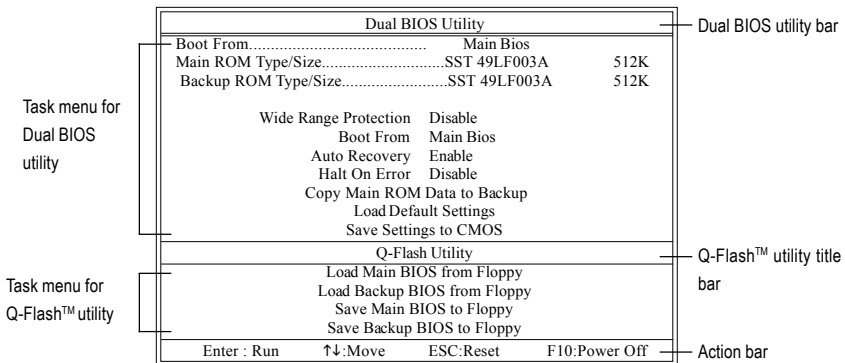

Task menu for Dual BIOS utility:

Contains the names of eight tasks and two item showing information about the BIOS ROM type. Blocking a task and pressing Enter key on your keyboard to enable execution of the task.

Task menu for Q-Flash utility:

Contains the names of four tasks. Blocking a task and pressing Enter key on your keyboard to enable execution of the task.

Action bar:

Contains the names of four actions needed to operate the Q-Flash/Dual BIOS utility. Pressing the buttons mentioned on your keyboards to perform these actions.

Using the Q-Flash™ utility:

This section tells you how to update BIOS using the Q-Flash utility. As described in the "Before you begin" section above, you must prepare a floppy disk having the BIOS file for your motherboard and insert it to your computer. If you have already put the floppy disk into your system and have entered the Q-Flash utility, please follow the steps below to flash BIOS.

Steps:

1. Press arrow buttons on your keyboard to move the light bar to "Load Main BIOS from Floppy" item in the Q-Flash menu and press Enter button.

Later, you will see a box pop up showing the BIOS files you previously downloaded to the floppy disk.



If you want to save the current BIOS for backup purpose, you can begin Step 1 with "Save Main BIOS to Floppy" item.

2. Move to the BIOS file you want to flash and press Enter.

In this example, we only download one BIOS file to the floppy disk so only one BIOS file, 8KNXPU.Fba, is listed.



Please confirm again you have the correct BIOS file for your motherboard.

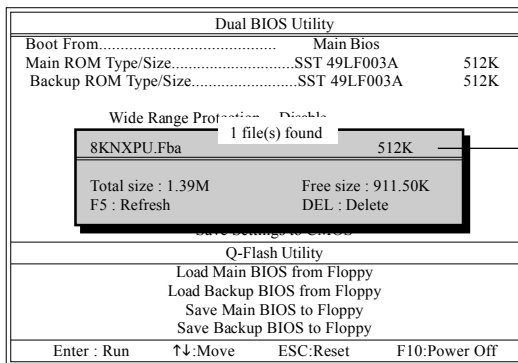

BIOS file in the floppy disk.

After pressing **Enter**, you'll then see the progress of reading the BIOS file from the floppy disk.

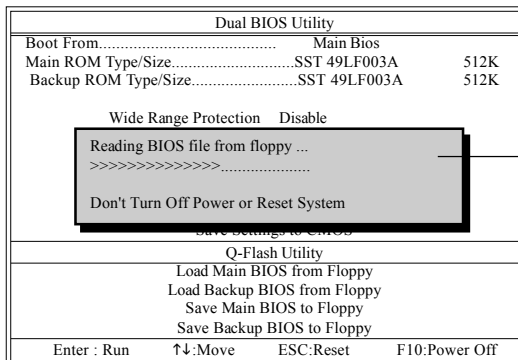

Do not turn off power or reset your system at this stage!!

After BIOS file is read, you'll see a confirmation dialog box asking you "Are you sure to update BIOS?"

- Press Y button on your keyboard after you are sure to update BIOS.
Then it will begin to update BIOS. The progress of updating BIOS will be displayed.



Please do not take out the floppy disk when it begins flashing BIOS.

- Press any keys to return to the Q-Flash menu when the BIOS updating procedure is completed.

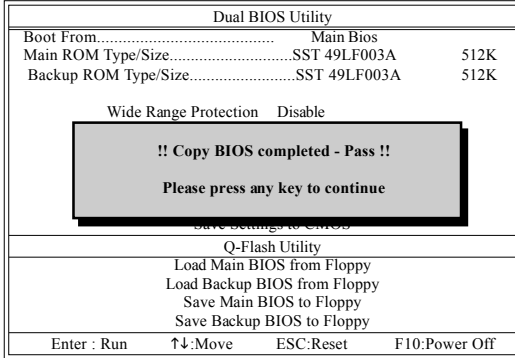

You can repeat Step 1 to 4 to flash the backup BIOS, too.

- Press Esc and then Y button to exit the Q-Flash utility. The computer will restart automatically after you exit Q-Flash.

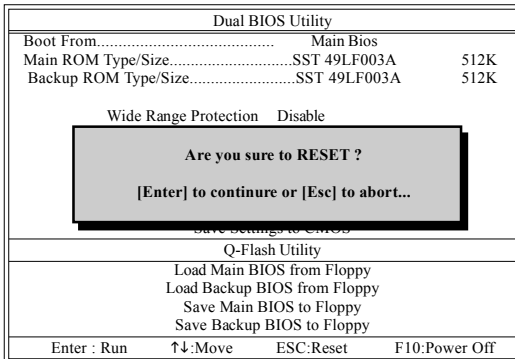

After system reboots, you may find the BIOS version on your boot screen becomes the one you flashed.

The BIOS file becomes Fba after updating.

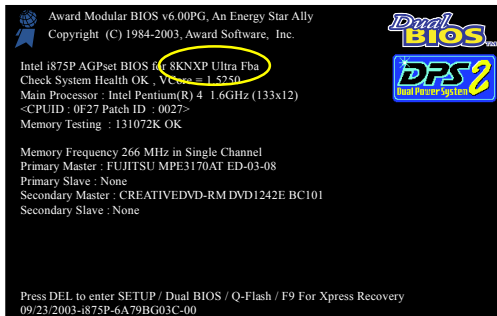

6. Press **Del** to enter BIOS menu after system reboots. When you are in BIOS menu, move to **Load Optimized Defaults** item and press **Enter** to load BIOS Optimized Defaults. Normally the system redetects all devices after BIOS has been upgraded. Therefore, we highly recommend reloading the BIOS defaults after BIOS has been upgraded.

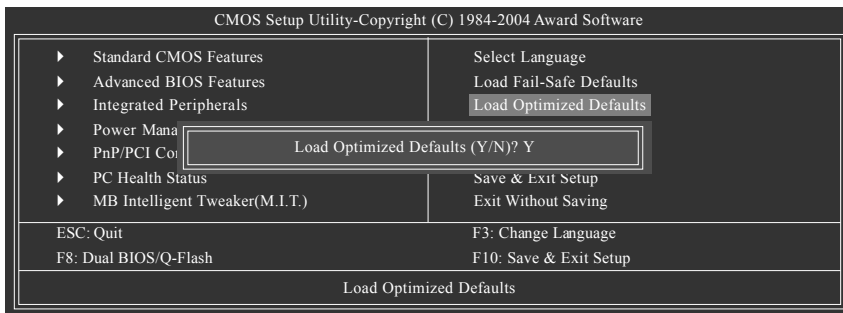

Press **Y** on your keyboard to load defaults.

7. Select **Save & Exit Setup** item to save the settings to CMOS and exit the BIOS menu. System will reboot after you exit the BIOS menu. The procedure is completed.

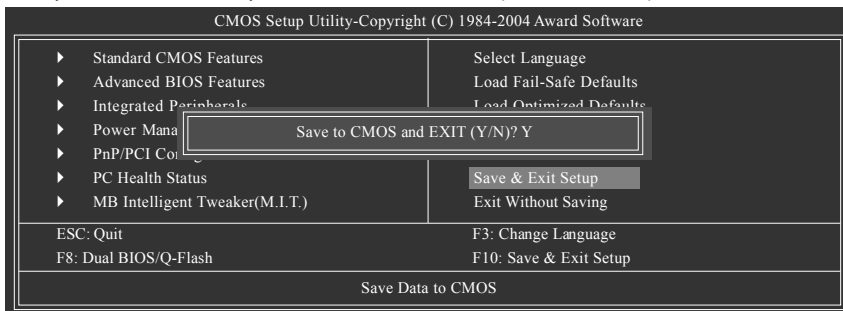

Press **Y** on your keyboard to save and exit.

Part Two:

Updating BIOS with Q-Flash™ Utility on Single-BIOS Motherboards.

This part guides users of single-BIOS motherboards how to update BIOS using the Q-Flash™ utility.

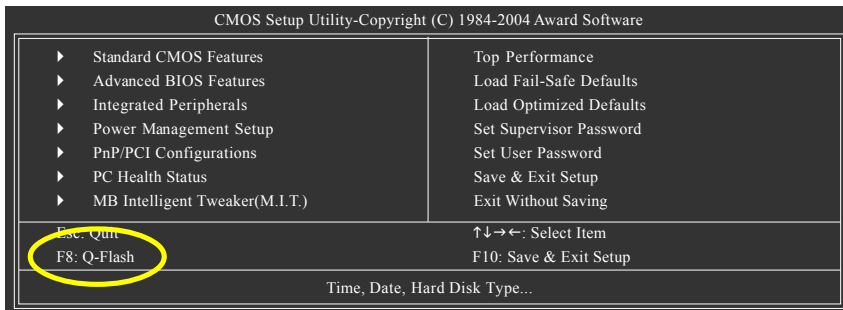

Exploring the Q-Flash™ utility screen

The Q-FlashBIOS utility screen consists of the following key components.

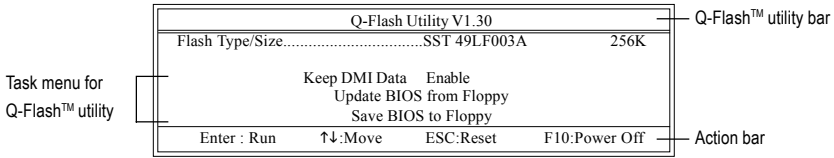

Task menu for Q-Flash utility:

Contains the names of three tasks. Blocking a task and pressing Enter key on your keyboard to enable execution of the task.

Action bar:

Contains the names of four actions needed to operate the Q-Flash utility. Pressing the buttons mentioned on your keyboards to perform these actions.

Using the Q-Flash™ utility:

This section tells you how to update BIOS using the Q-Flash utility. As described in the "Before you begin" section above, you must prepare a floppy disk having the BIOS file for your motherboard and insert it to your computer. If you have already put the floppy disk into your system and have entered the Q-Flash utility, please follow the steps below to flash BIOS.

Steps:

1. Press arrow buttons on your keyboard to move the light bar to "Update BIOS from Floppy" item in the Q-Flash menu and press Enter button.
Later, you will see a box pop up showing the BIOS files you previously downloaded to the floppy disk.



If you want to save the current BIOS for backup purpose, you can begin Step 1 with "Save BIOS to Floppy" item.

2. Move to the BIOS file you want to flash and press Enter.

In this example, we only download one BIOS file to the floppy disk so only one BIOS file, 8GE800.F4, is listed.



Please confirm again you have the correct BIOS file for your motherboard.

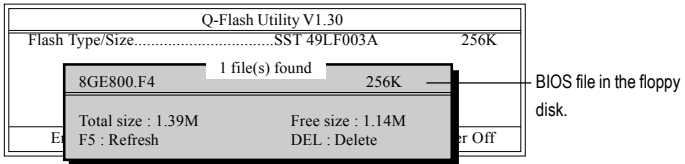

Do not turn off power or reset your system at this stage!!

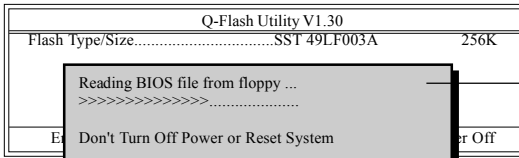

After BIOS file is read, you'll see a confirmation dialog box asking you "Are you sure to update BIOS?"



Please do not take out the floppy disk when it begins flashing BIOS.

- Press Y button on your keyboard after you are sure to update BIOS.
Then it will begin to update BIOS. The progress of updating BIOS will be shown at the same time.

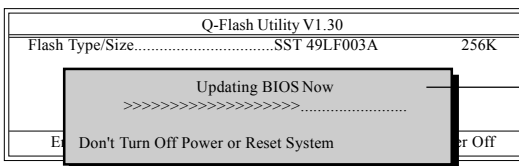

Do not turn off power or reset your system at this stage!!

- Press any keys to return to the Q-Flash menu when the BIOS updating procedure is completed.

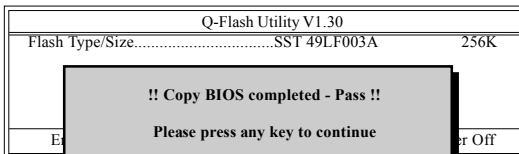

- Press Esc and then Y button to exit the Q-Flash utility. The computer will restart automatically after you exit Q-Flash.

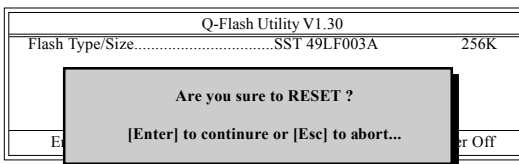

After system reboots, you may find the BIOS version on your boot screen becomes the one you flashed.

The BIOS file becomes F4 after updating

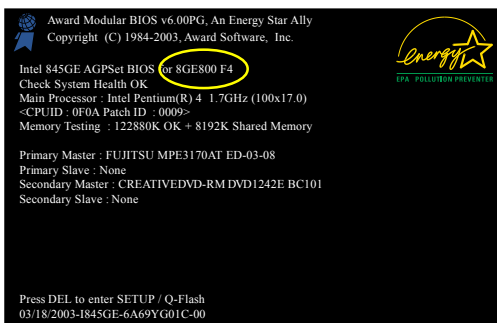

- Press Del to enter BIOS menu after system reboots and "Load BIOS Fail-Safe Defaults". See how to Load BIOS Fail-Safe Defaults, please kindly refer to Step 6 to 7 in **Part One**.

Congratulation!! You have updated BIOS successfully!!

Method 2 : @BIOS™ Utility

If you do not have a DOS startup disk, we recommend that you use the new @BIOS utility. @BIOS allows users to update their BIOS under Windows. Just select the desired @BIOS server to download the latest version of BIOS.

Fig 1. Installing the @BIOS utility

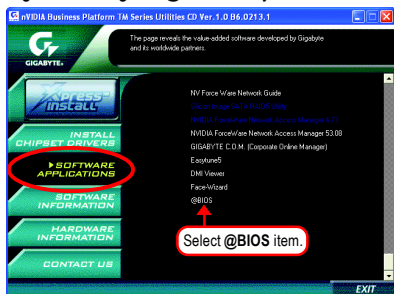

Fig 2. Installation complete and run @BIOS

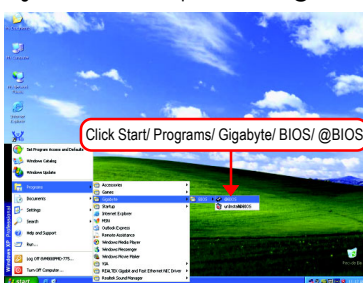

Fig 3. The @BIOS utility

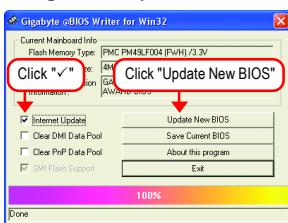
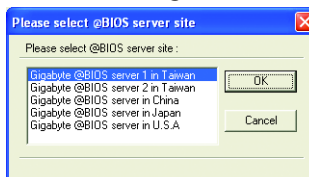

Fig 4. Select the desired @BIOS server



1. Methods and steps:

I. Update BIOS through Internet:

- a. Click "Internet Update" icon.
- b. Click "Update New BIOS" icon.
- c. Select @BIOS™ sever.
- d. Select the exact model name on your motherboard.
- e. System will automatically download and update the BIOS.

II. Update BIOS NOT through Internet:

- a. Do not click "Internet Update" icon.
- b. Click "Update New BIOS".
- c. Please select "All Files" in dialog box while opening the old file.
- d. Please search for BIOS unzip file, downloading from internet or any other methods (such as: 51PVM9NV.F3).
- e. Complete update process following the instruction.

III. Save BIOS:

In the very beginning, there is "Save Current BIOS" icon shown in dialog box. It means to save the current BIOS version.

IV. Check out supported motherboard and Flash ROM:

In the very beginning, there is "About this program" icon shown in dialog box. It can help you check out which kind of motherboard and which brand of Flash ROM are supported.

2. Note:

- I. In method I, if it shows two or more motherboard's model names to be selected, please make sure your motherboard's model name again. Selecting wrong model name will cause the system unbooted.
- II. In method II, be sure that motherboard's model name in BIOS unzip file are the same as your motherboard's. Otherwise, your system won't boot.
- III. In method I, if the BIOS file you need cannot be found in @BIOS™ server, please go onto Gigabyte's website for downloading and updating it according to method II.
- IV. Please note that any interruption during updating will cause system unbooted.
- V. Do not use @BIOS and C.O.M. (Corporate Online Management) at the same time.

4-1-4 Configuring SATA Hard Drive(s) (Controller: nVIDIA nForce 430)

To configure SATA hard drive(s), follow the steps below:

- (1) Install SATA hard drive(s) in your system.
- (2) Configure SATA controller mode and boot sequence in BIOS Setup.
- (3)* Configure RAID set in RAID BIOS.
- (4) Make a floppy disk containing the SATA controller driver.
- (5) Install the SATA controller driver during OS installation.

Before you begin

Please prepare:

- (a) At least two SATA hard drives (to ensure optimal performance, it is recommended that you use two hard drives with identical model and capacity). If you do not want to create RAID, you may prepare only one hard drive.
- (b) An empty formatted floppy disk.
- (c) Windows XP/2000 setup disk.
- (d) Driver CD for your motherboard.

(1) Installing SATA hard drive(s) in your computer

Attach one end of the SATA signal cable to the rear of the SATA hard drive and the other end to available SATA port(s) on the motherboard. If there are more than one SATA controller on your motherboard, you may refer to the motherboard user's manual to identify the SATA controller for the connector. Then connect the power connector from your power supply to the hard drive.

*** Skip this step if you do not want to create RAID array on the SATA controller.

(2) Configuring SATA controller mode and boot sequence in BIOS Setup

You have to make sure whether the SATA controller is configured correctly in system BIOS Setup and set BIOS boot sequence for the SATA hard drive(s)/RAID array.

Step 1:

Turn on your computer and press Del to enter BIOS Setup during POST (Power-On Self Test). In the example in Figure 1, make sure that **Serial-ATAII 1** or **Serial-ATAII 2** under the **Integrated Peripherals** menu is enabled (**Serial-ATAII1** controls the SATAII0/1 connectors and **Serial-ATAII2** controls the SATAII2/3 connectors). If you wish to create RAID array, press ENTER on the **SATAII RAID Config** item to enter the submenu .

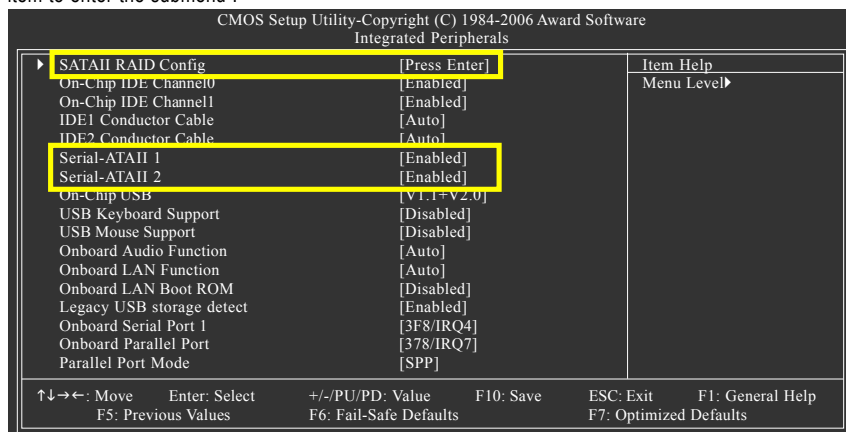

Figure 1

In the **SATAII RAID Config** submenu, enable **SATA-II RAID function**. Then enable the SATA ports with hard disks that you want to use for RAID. In the example in Figure 2, enable **SATA-II 1 Primary/Secondary RAID** or **SATA-II 2 Primary/Secondary RAID**. (For example, if you wish to create RAID with hard disks on the SATAII0 and SATAII1 connectors, set **SATA-II 1 Primary/Secondary RAID to Enabled**).

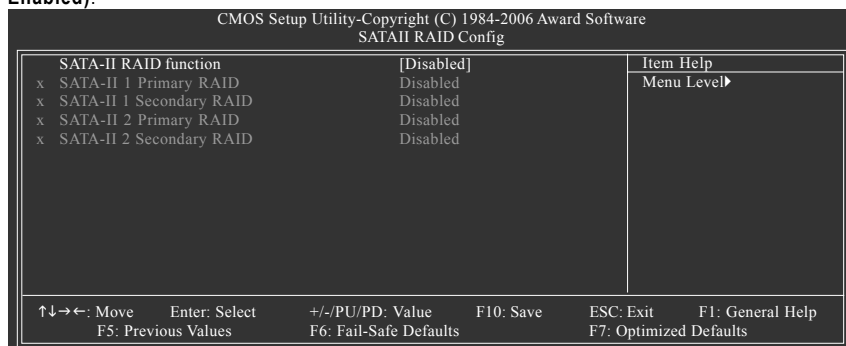

Figure 2



NOTE

The BIOS Setup menus described in this section may not show the exact settings for your motherboard. The actual BIOS Setup menu options you will see shall depend on the motherboard you have and the BIOS version.

Step 2:

If you do not create RAID, select **Hard Disk Boot Priority** under the **Advanced BIOS Features** menu. In the **Hard Disk Boot Priority** submenu, select the model of the SATA hard drive onto which you wish to install Microsoft Windows 2000/XP. You should see a screen similar to Figure 3 below.

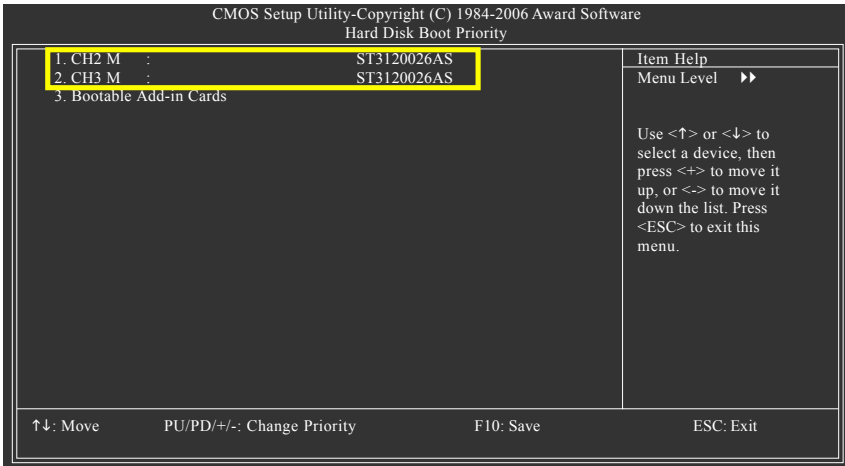

Figure 3

After configuring the SATA controller mode in system BIOS, if you wish to create RAID, save the settings and exit. Then go to RAID BIOS (refer to page 69) to configure the RAID array. After finished, re-enter the system BIOS Setup to set hard disk boot priority before OS installation. Select **Hard Disk Boot Priority** under the **Advanced BIOS Features** menu. In the **Hard Disk Boot Priority** submenu, select the RAID array onto which you wish to install Microsoft Windows 2000/XP (Figure 4).

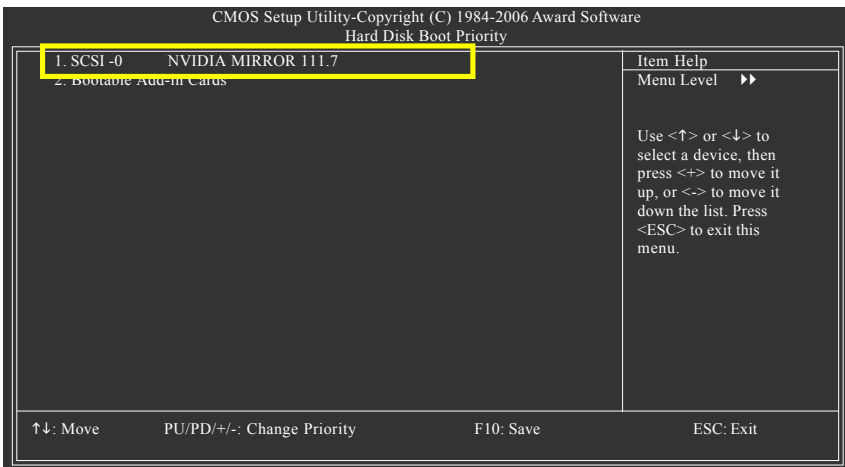

Figure 4

Step 3:

To boot from Windows installation CD-ROM, set **First Boot Device** under the **Advanced BIOS Features** menu to **CDROM** (Figure 5).

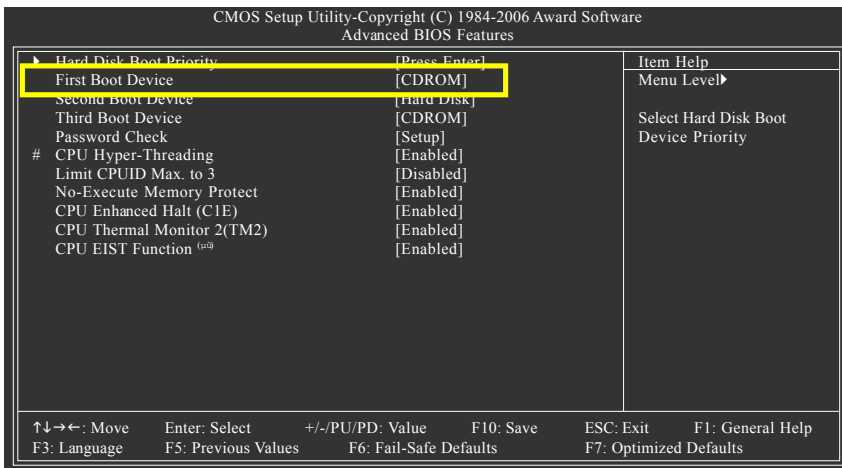

Figure 5

Step 4:

Save and exit BIOS Setup.

(3) Configuring RAID set in RAID BIOS

Enter the RAID BIOS setup utility to configure a RAID array. Skip this step and proceed to Section 4 if you do not want to create RAID.

Step 1:

After the POST memory test begins and before the operating system boot begins, look for a message which says "Press F10 to enter RAID setup utility" (Figure 6). Hit the **F10** key to enter the RAID BIOS setup utility.

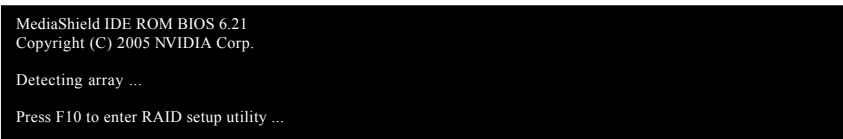

Figure 6

Step 2:

The Define a New Array screen is the first option screen when you enter the NVIDIA RAID setup utility. (Figure 7). You can press the TAB key to highlight through options.

Step 3:

In the RAID Mode field, use the UP or DOWN ARROW key to select a RAID mode. The supported RAID modes include Mirroring (default), Striping. The following is an example of RAID 0 array creation.

Step 4:

If RAID 0 (Striping) is selected, you can manually set the striping block size. In the Striping Block field, use the UP or DOWN ARROW key to set the Striping Block size. The KB is the standard unit of Striping Block size. We recommend you leaving it to the default setting--Optimal (64K). The size range is from 4K to 128K.

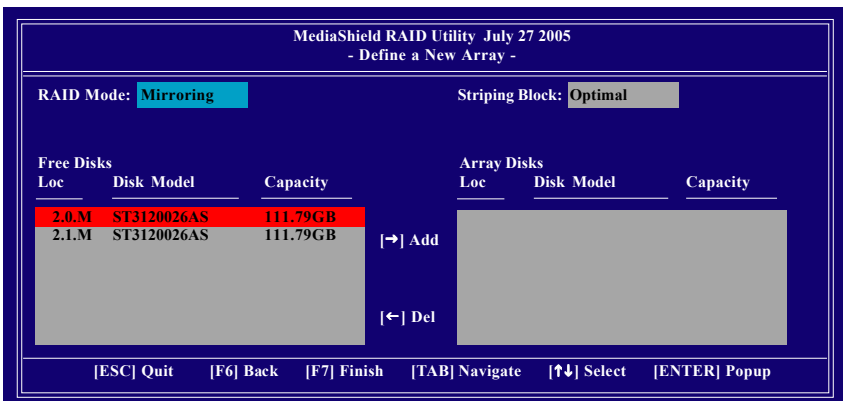

Figure 7

Step 5:

Next, select the hard drives which you wish to be included in the disk array. The Free Disks section displays the information about the currently installed SATA hard drives. Press the TAB key to move to the Free Disks section. Select the target hard drives using the UP or DOWN ARROW key and use the RIGHT ARROW key to add the hard drives to the Array Disks section (Figure 8).

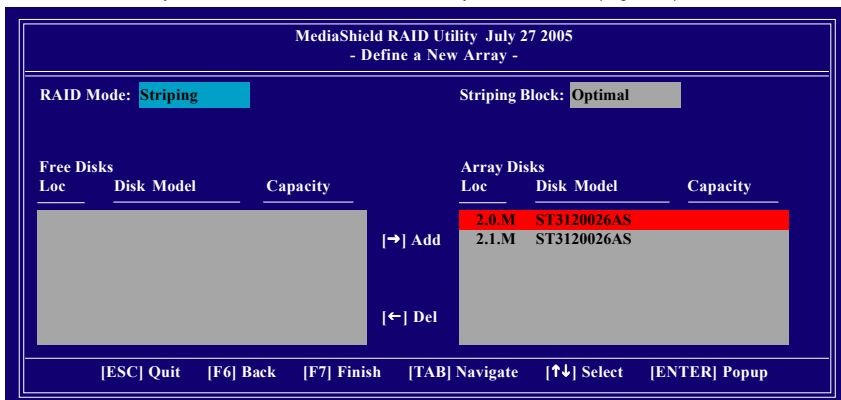

Figure 8

Step 6:

Press F7 after selecting the target hard disks. A message which says "Clear disk data?" will appear (Figure 9). If you are sure to clear the data in the selected hard drives, press Y. (If the hard drives contain previously created RAID array, you need to press Y to clear the data from the hard drives.)

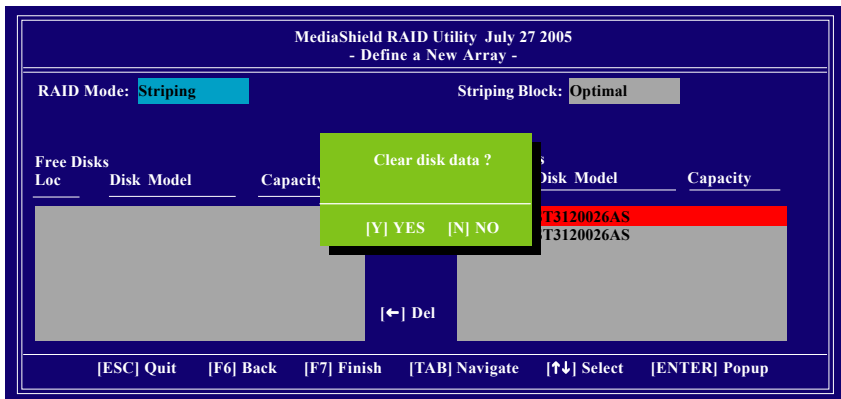

Figure 9

(4) Making a SATA Driver Disk

To install operating system onto a serial ATA hard disk successfully, you need to install the SATA controller driver during OS installation. Without the driver, the hard disk may not be recognized during the Windows setup process. First of all, copy the driver for the SATA controller from the motherboard driver CD-ROM to a floppy disk. See the instructions below about how to copy the driver in MS-DOS mode^(Note). Prepare a startup disk that has CD-ROM support and a blank formatted floppy disk.

Step 1: Insert the prepared startup disk and motherboard driver CD-ROM in your system. Boot from the startup disk. Once at the A:\> prompt, change to the CD-ROM drive (example: D:\>). At the D:\> prompt, type the following two commands. Press ENTER after each command (Figure 12):

```
cd bootdrv
menu
```

Step 2: When the controller menu (Figure 13) appears, remove the startup disk and insert the blank formatted disk. Select the controller driver by pressing the corresponding letter from the menu. For example, from the menu in Figure 13, press I to select I) nVIDIA C51 Series Raid(XP) if you wish to install Windows XP. Your system will then automatically zip and transfer this driver file to the floppy disk. Press 0 to exit when finished.

```
02/13/2006 04:57 PM      5,591 CH1.INI
02/13/2006 07:09 PM      <DIR>      Chipset
07/21/2005 05:54 PM      99,394 Hsdlhpl.dll
08/21/2002 10:11 AM      53,248 HUBBRD.DLL
07/12/2005 02:18 PM      23,181 ID.LOC
02/13/2006 07:09 PM      <DIR>      Network
10/08/2002 07:51 PM      38,857 OEMSETUP.INF
12/09/2005 05:55 PM      2,700 README.TXT
02/06/2006 02:57 PM      434,176 Setup.exe
07/09/2004 10:01 AM      2,839 TTP.INI
03/11/2005 05:22 PM      192,512 TestV.exe
02/13/2006 07:09 PM      <DIR>      Utility
02/13/2006 07:09 PM      <DIR>      Vcd
12/07/2005 08:39 PM      9,823 Wcd.txt
04/25/2005 06:12 PM      61,440 WCD.DLL
12/15/2005 11:45 AM      <DIR>      boot
02/13/2006 07:18 PM      2,048 boot.catalog
12/15/2005 11:45 AM      <DIR>      release
14 File(s)      930,466 bytes
          9 Dir(s)      0 bytes free

F:\>cd bootdrv
F:\BootDrv>menu
```

Figure 12

```
1)Promise 20276 ATA
2)Promise 20276 RAID
3)Promise 20265 ATA
4)Promise 20265 ATA(XP)
5)Promise 20265 RAID
6)Promise 20265 RAID(XP)
7)Promise 20779 SATA
8)Promise 20779 RAID
9)S11314 ATA
0)S11314 RAID
0)S11314 RAID5
C)NVIDIA CR804 Series Raid(XP)
D)NVIDIA CR804 Parallel Raid(XP)
E)NVIDIA CR804 Series Raid(2K)
F)NVIDIA CR804 Parallel Raid(2K)
G)NVIDIA C19 Series Raid(XP)
H)NVIDIA C19 Series Raid(2K)
I)NVIDIA C51 Series Raid(XP)
J)NVIDIA C51 Series Raid(2K)
0)exit
```

Figure 13

(Note) For users without a startup disk:

Use an alternative system and insert the GIGABYTE motherboard driver CD-ROM. From the CD-ROM drive folder, double click the **MENU.exe** file in the **BootDrv** folder (Figure 14). A command prompt window will open similar to that in Figure 13.

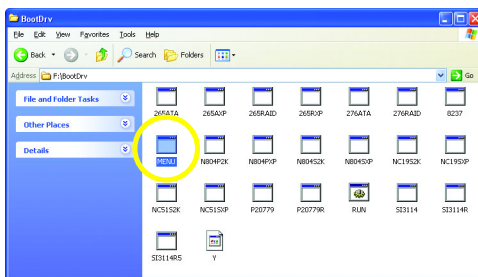

Figure 14

(5) Installing SATA controller driver during OS installation

Now that you have prepared the SATA driver disk and configured BIOS settings, you are ready to install Windows 2000/XP onto your SATA hard drive with the SATA driver. The following is an example of Windows XP installation.

Step 1: Restart your system to boot from the Windows 2000/XP Setup disk and press F6 as soon as you see the "Press F6 if you need to install a 3rd party SCSI or RAID driver" message (Figure 15). After pressing F6, there will be a few moments of some files being loaded before you see the next screen.

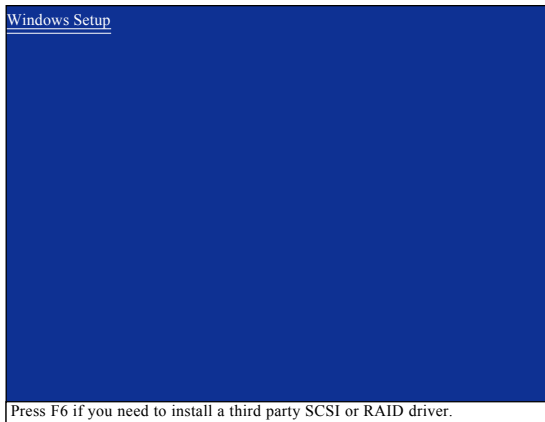

Figure 15

Step 2:

When a screen similar to that below appears, insert the floppy disk containing the SATA driver and press S (Figure 16).

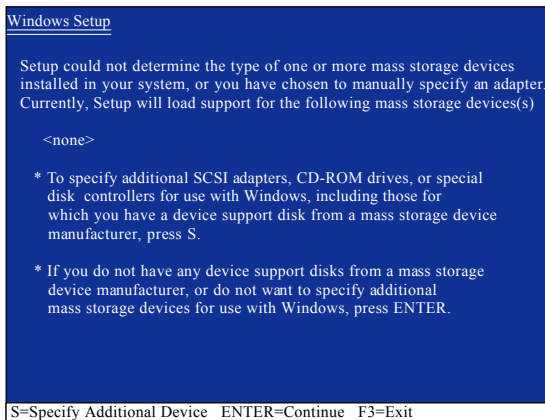

Figure 16

Step 3:

If Setup correctly recognizes the driver in the floppy disk, a controller menu similar to Figure 17 below will appear. Use the ARROW keys to select **NVIDIA RAID CLASS DRIVER*** (Figure 17) and press ENTER. Later, when a screen similar to Figure 18 appears, you must press S to select additional driver. The screen will return to previous screen as shown in Figure 17. Select **NVIDIA nForce Storage Controller** and press ENTER.

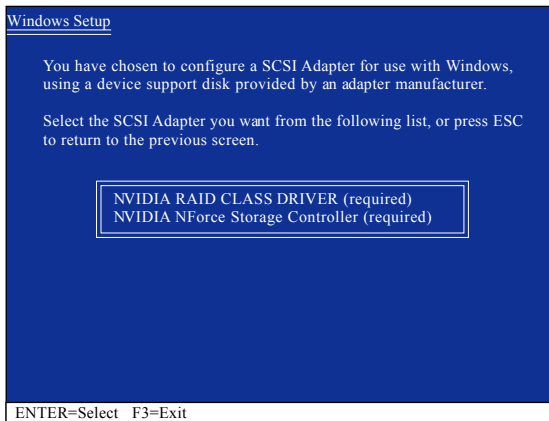

Figure 17

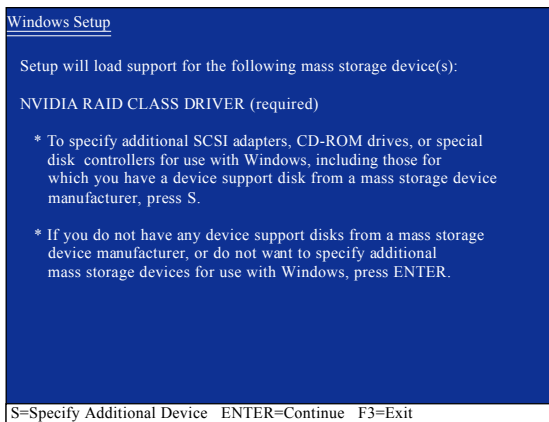

Figure 18



If a message appears saying one or some file(s) cannot be found, please check the floppy disk or copy the correct SATA driver again from the motherboard driver CD.

*** If you want to create RAID, select both **NVIDIA RAID CLASS DRIVER** and then **NVIDIA nForce Storage Controller**.

If you do not create RAID, select **NVIDIA nForce Storage Controller** only.

Step 4:

When the next screen (Figure 19) appears, press ENTER to continue the SATA driver installation from the floppy disk.

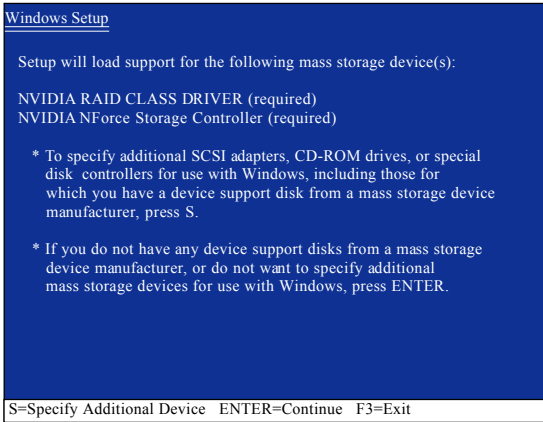

Figure 19

After the SATA controller driver installation is completed, you should see a screen similar to that below. You can proceed with the Windows 2000/XP installation now.

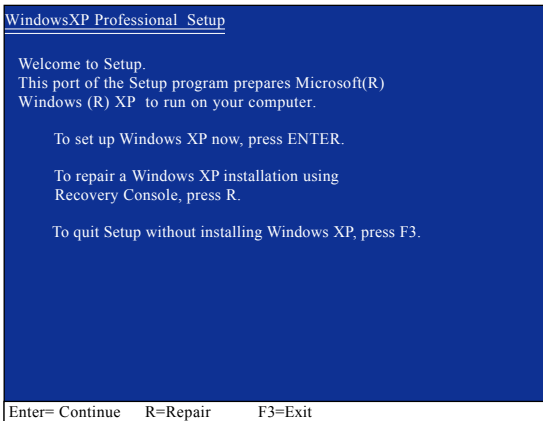

Figure 20

(6) Configuring a bootable RAID array with Microsoft Windows 2000

Problem: Users cannot install Windows 2000 with Service Pack 2 (or previous versions) to a bootable RAID volume.

There are two solutions to resolve this issue.

Solutions 1:

Use the NVRAID tool (nForce Driver Version 5.xx) to convert the boot volume to a RAID array. Here are the detailed step-by-step instructions:

Step 1:

Install Windows 2000 onto a selected hard drive. Download and install Windows 2000 Service Pack 4 from Microsoft's website.

Step 2:

After system restarts, press Del to enter system BIOS Setup during POST (Power-On Self Test). Under the **Integrated Peripherals** menu (Figure 21) assure the SATA port connecting the SATA hard disk (the one containing the Windows 2000) is **Enabled** (Figure 21/22). Save settings and exit the BIOS setup.

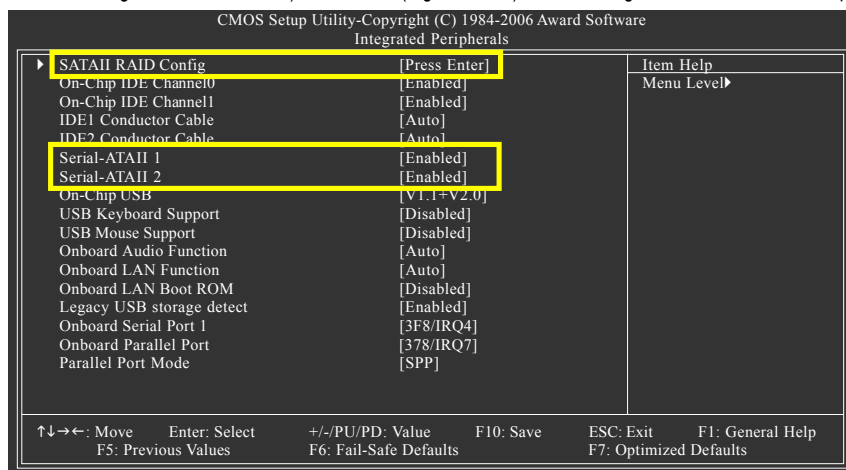

Figure 21

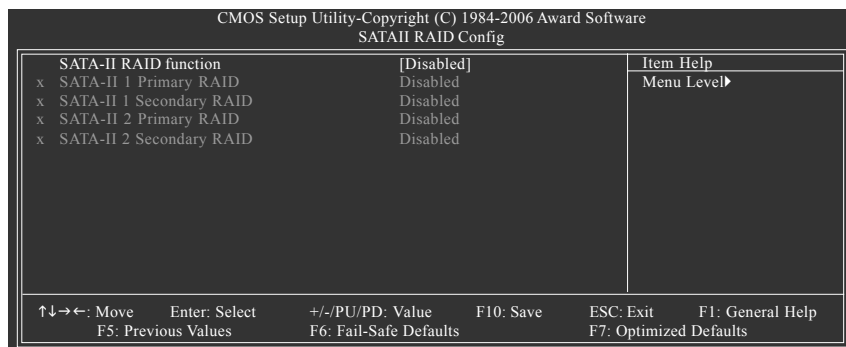

Figure 22

Step 3:

After system restarts, press F10 to enter the NVIDIA RAID setup utility. Select Striping in the RAID Mode field (Figure 23). Move to the Free Disks section with the TAB key. Select the desired disk and use the RIGHT ARROW key to add it to Array Disks menu.

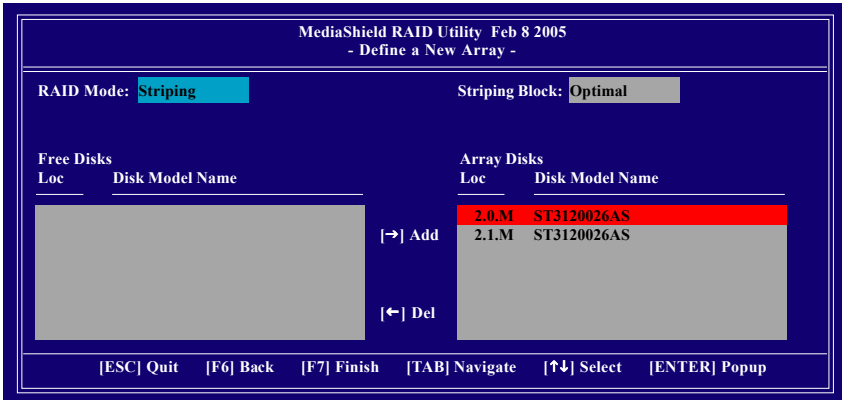

Figure 23

Step 4:

After all the settings, press F7 to complete the configuration. When prompted to **Clear Disk Data** (Figure 24), press N. Then press CTRL+X to exit the NVIDIA RAID BIOS. Restart the computer to boot into Windows 2000.

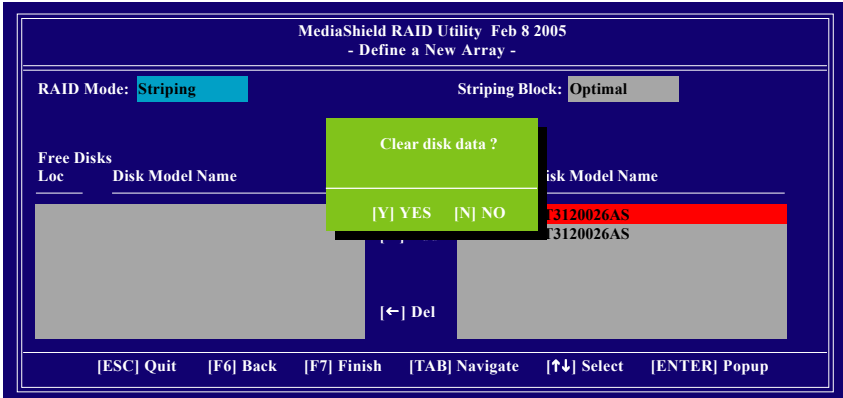

Figure 24

Step 5:

Install the NVIDIA nForce Driver Package while in Windows 2000 and reboot the system. Go to **START> Programs>Nvidia Corporation** and select **NVRAID manager**. You should see the single disk RAID array (in striping mode) that was created from the boot disk. Select the single boot disk RAID Array by clicking on it. Select **Convert Array** under the **System Tasks** and select **Next** following the instructions. Select the desired type of RAID array you want to convert and then select **Next**. You are prompted to select the desired Free Disk(s) to add to the bootable RAID array. Press **Finish** then NVRAID will start converting the single disk RAID array into a multi-disk RAID array in a bootable format.

Note: Conversion may take 1~2 hours depending on disk size.

Solutions 2:

Users must create a combination installation CD that includes Windows 2000 and Service Pack 3 or Service Pack 4 fixes integrated in. To create the combination installation CD, refer to the following website:

<http://www.microsoft.com/windows2000/downloads/servicepacks/sp4/HFdeploy.htm>

Note: If users choose not to install Windows 2000 Service Pack 3 or 4, RAID is still supported on Windows 2000. However, users will not be able to create a bootable RAID volume.



4-1-5 2- / 4- / 6- / 8- Channel Audio Function Introduction

The default speaker settings for the 3 audio jacks are as shown in the picture to the right. The jack retasking capability supported by HD Audio allows users to change the function for each audio jack by the audio software provided. Please follow the steps to install the function. (Following pictures are in Windows XP)

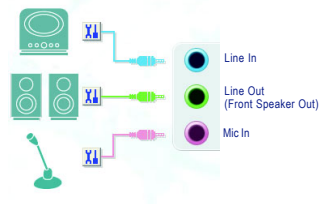

HD Audio

With multiple built-in high quality digital-to-analog converters (DACs) that support audio output at up to 192 kHz/24-bit quality and multi-streaming applications, HD Audio is able to handle multiple audio streams (in and out) simultaneously. Multi-channel audio experiences have become a reality so you can, for instance, listen to MP3 music, have an Internet chat, make a telephone call over the Internet, and etc. all at the same time.

Stereo Speakers Connection and Settings:

We recommend that you use the speaker with amplifier to acquire the best sound effect if the stereo output is applied.

STEP 1 :

After installation of the audio driver, you should find an Audio Manager icon in your system tray (you can also find the icon in Control Panel). Double-click the icon to open the Audio Control Panel.

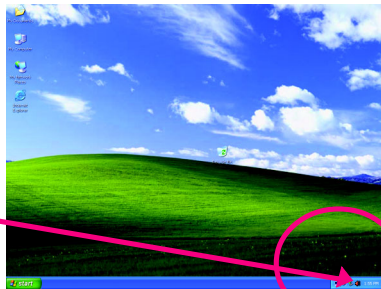

STEP 2:

In the Audio Control Panel, click the **Audio I/O** tab.
In the upper left list, click **2CH Speaker**.

**STEP 3:**

After a speaker or headphone is plugged into the rear Line Out jack, a small window will pop up and ask you what type of equipment is connected. Choose **Headphone** or **Line Out** depending on the device connected and click **OK**. The 2-channel audio setup is completed.

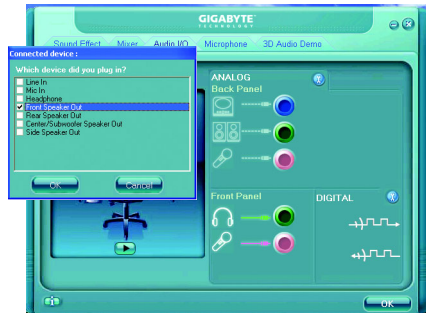
**4 Channel Audio Setup****STEP 1 :**

After installation of the audio driver, you should find an Audio Manager icon in your system tray (you can also find the icon in Control Panel). Double-click the icon to open the Audio Control Panel.

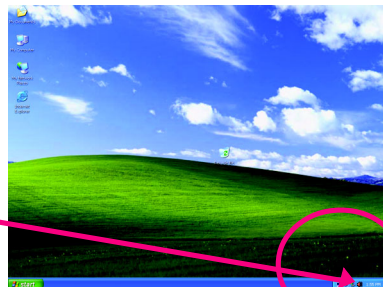
**STEP 2:**

In the Audio Control Panel, click the **Audio I/O** tab.
In the upper left list, click **4CH Speaker**.



STEP 3:

After plugging in 4-channel speakers to the rear speaker jacks, a small window will pop up and ask you what type of equipment is connected. Choose a device depending on the type of speaker connected (4-channel audio consists of Front Speaker Out (Line Out) and Rear Speaker Out) and then click **OK**. The 4-channel audio setup is completed.

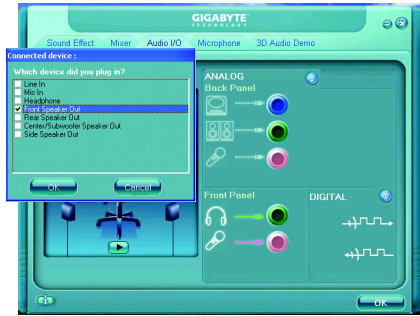
**6 Channel Audio Setup****STEP 1 :**

After installation of the audio driver, you should find an Audio Manager icon in your system tray (you can also find the icon in Control Panel). Double-click the icon to open the Audio Control Panel.

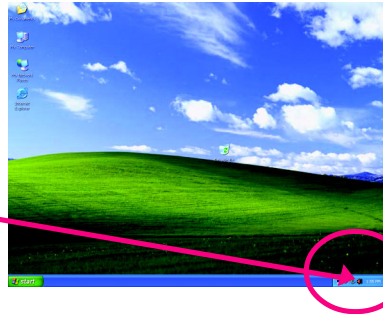
**STEP 2:**

In the Audio Control Panel, click the **Audio I/O** tab. In the upper left list, click **6CH Speaker**.

**STEP 3:**

After plugging in 6-channel speakers to the rear speaker jacks, a small window will pop up and ask you what type of equipment is connected. Choose a device depending on the type of speaker connected (6-channel audio consists of Front Speaker Out (Line Out), Rear Speaker Out, and Center/Subwoofer Speaker Out) then click **OK**. The 6-channel audio setup is completed.

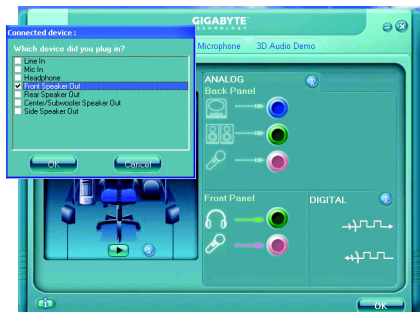

8 Channel Audio Setup

To achieve 8-Channel Audio, you have to connect the front panel audio module to the F_AUDIO connector on the motherboard. Then select the type of equipment from the pop up menu. Note that the audio module should be the HD (High Definition) specification.

STEP 1 :

After installation of the audio driver, you should find an Audio Manager icon in your system tray (you can also find the icon in Control Panel). Double-click the icon to open the Audio Control Panel.



STEP 2:

In the Audio Control Panel, click the **Audio I/O** tab. In the upper left list, click **8CH Speaker**.

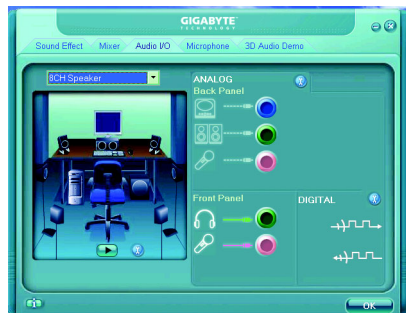

STEP 3:

After plugging in 8-channel speakers, a small window will pop up and ask you what type of equipment is connected.

Choose a device depending on the type of speaker connected (8-channel audio consists of Front Speaker Out (Line Out), Rear Speaker Out, Center/Subwoofer Speaker Out, and Side Speaker Out) then click **OK**. The 8-channel audio setup is completed.



Sound Effect Configuration:

At the **Sound Effect** menu, users can adjust sound option settings as desired.



AC'97 Audio Configuration:

To enable the front panel audio connector to support AC97 Audio mode, go to the Audio Control Panel and click the **Audio I/O** tab. In the **ANALOG** area, click the **Tool** icon and then select the **Disable front panel jack detection** check box. This action completes the AC'97 Audio configuration.

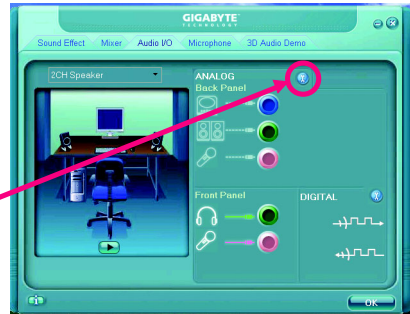

4-1-6 Introduction of the TPM Security Solution

This product is equipped with the TPM (Trusted Platform Module) security chip, promoted by the Trusted Computing Group (TCG). TCG members include Microsoft, Sony, Sun Microsystems, IBM, HP, AMD, Intel and other big IT companies. The TPM is implemented in computer identification devices, consisting of TPM hardware (the TPM chip) and its supporting software (the Infineon Security Platform). The TPM basically is a micro-chip affixed to a motherboard. It can store important data like keys, passwords, and digital certificates and is able to prevent theft on important data from external software. The TPM can also protect hard disk data through its supporting software.

Introduction to the Infineon Security Platform

The Infineon Security Platform software includes a full set of tools. It provides functionalities like creating digital certificates and management of these certificates, encrypting files and documents, and setting customer e-mail servers to send digitally signed and encrypted e-mails, etc.

To use this function, go to Start / Program Files / Infineon Security Platform Solution / Manage Security Platform, or click the  icon in the system tray at the lower right corner of the Windows Desktop.

Please refer to the online help for detailed introduction and directions to the software.

4-2 Troubleshooting

Below is a collection of general asked questions. To check general asked questions based on a specific motherboard model, please log on to GIGABYTE's website.

Question 1: I cannot see some options that were included in previous BIOS after updating BIOS. Why?

Answer: Some advanced options are hidden in new BIOS version. Please press Ctrl and F1 keys after entering BIOS menu and you will be able to see these options.

Questions 2: Why is the light of my keyboard/optical mouse still on after computer shuts down?

Answer: In some boards, a small amount of electricity is kept on standby after computer shuts down and that's why the light is still on.

Question 3: How do I clear CMOS?

Answer: If your board has a Clear CMOS jumper, please refer to the Clear CMOS steps in the manual. If your board doesn't have such jumper, you can take off the on-board battery to leak voltage to clear CMOS. Please refer to the steps below:

Steps:

1. Turn off power.
2. Disconnect the power cord from MB.
3. Take out the battery gently and put it aside for about 1 minute (Or you can use a metal object to connect the positive and negative pins in the battery holder to makethem short for 5 seconds).
4. Re-insert the battery to the battery holder.
5. Connect power cord to MB again and turn on power.
6. Press Del to enter BIOS and load Fail-Safe Defaults(or load Optimized Defaults).
7. Save changes and reboot the system.

Question 4: Why do I still get a weak sound after turning up the speaker to the maximum volume?

Answer: Please make sure the speaker you are using is equipped with an internal amplifier. If not, please change another speaker with power/amplifier and try again later.

Question 5: Sometimes I hear different continuous beeps from computer after system boots up. What do these beeps usually stand for?

Answer: The beep codes below may help you identify the possible computer problems. However, they are only for reference purposes. The situations might differ from case to case.

→ AWARD BIOS Beep Codes

1 short: System boots successfully

2 short: CMOS setting error

1 long 1 short: DRAM or M/B error

1 long 2 short: Monitor or display card error

1 long 3 short: Keyboard error

1 long 9 short: BIOS ROM error

Continuous long beeps: DRAM error

Continuous short beeps: Power error



Contact Us

- **Taiwan (Headquarters)**

GIGA-BYTE TECHNOLOGY CO., LTD.

Address: No.6, Bau Chiang Road, Hsin-Tien,

Taipei 231, Taiwan

TEL: +886-2-8912-4888

FAX: +886-2-8912-4003

Tech. and Non-Tech. Support (Sales/Marketing) :

<http://ggts.gigabyte.com.tw>

WEB address (English): <http://www.gigabyte.com.tw>

WEB address (Chinese): <http://www.gigabyte.tw>

- **U.S.A.**

G.B.T. INC.

TEL: +1-626-854-9338

FAX: +1-626-854-9339

Tech. Support:

<http://rma.gigabyte-usa.com>

Web address: <http://www.gigabyte.us>

- **Mexico**

G.B.T Inc (USA)

Tel: +1-626-854-9338 x 215 (Soporte de habla hispano)

FAX: +1-626-854-9339

Correo: soporte@gigabyte-usa.com

Tech. Support:

<http://rma.gigabyte-usa.com>

Web address: <http://www.gigabyte-latam.com>

- **Japan**

NIPPON GIGA-BYTE CORPORATION

WEB address : <http://www.gigabyte.co.jp>

- **Singapore**

GIGA-BYTE SINGAPORE PTE. LTD.

WEB address : <http://www.gigabyte.com.sg>

- **China**

NINGBO G.B.T. TECH. TRADING CO., LTD.

WEB address : <http://www.gigabyte.cn>

- **Shanghai**

TEL: +86-21-63410999

FAX: +86-21-63410100

- **Beijing**

TEL: +86-10-62102838

FAX: +86-10-62102848

- **Wuhan**

TEL: +86-27-87851061

FAX: +86-27-87851330

- **GuangZhou**

TEL: +86-20-87540700

FAX: +86-20-87544306 ext. 333

- **Chengdu**

TEL: +86-28-85236930

FAX: +86-28-85256822 ext. 814

- **Xian**

TEL: +86-29-85531943

FAX: +86-29-85539821

- **Shenyang**

TEL: +86-24-83992901

FAX: +86-24-83992909

- **India**

GIGABYTE TECHNOLOGY (INDIA) LIMITED

WEB address : <http://www.gigabyte.in>

- **Australia**

GIGABYTE TECHNOLOGY PTY. LTD.

WEB address : <http://www.gigabyte.com.au>

- **Germany**

G.B.T. TECHNOLOGY TRADING GMBH

WEB address : <http://www.gigabyte.de>

- **U.K.**

G.B.T. TECH. CO., LTD.

WEB address : <http://www.giga-byte.co.uk>

- **The Netherlands**

GIGA-BYTE TECHNOLOGY B.V.

WEB address : <http://www.giga-byte.nl>

- **France**

GIGABYTE TECHNOLOGY FRANCE

WEB address : <http://www.gigabyte.fr>

- **Italy**

WEB address : <http://www.giga-byte.it>

- **Spain**

GIGA-BYTE SPAIN

WEB address : <http://www.giga-byte.es>

- **Czech Republic**

Representative Office Of GIGA-BYTE Technology Co., Ltd.
in CZECH REPUBLIC

WEB address : <http://www.gigabyte.cz>

- **Turkey**

Representative Office Of GIGA-BYTE Technology Co., Ltd.
in TURKEY

WEB address : <http://www.gigabyte.com.tr>

- **Russia**

Moscow Representative Office Of GIGA-BYTE Technology Co., Ltd.

WEB address : <http://www.gigabyte.ru>

- **Latvia**

GIGA-BYTE Latvia

WEB address : <http://www.gigabyte.com.lv>

- **Poland**

Office of GIGA-BYTE TECHNOLOGY Co., Ltd. in POLAND

WEB address : <http://www.gigabyte.pl>

- **Ukraine**

WEB address : <http://www.gigabyte.kiev.ua>

- **Romania**

Representative Office Of GIGA-BYTE Technology Co., Ltd.
in Romania

WEB address : <http://www.gigabyte.com.ro>

- **Serbia & Montenegro**

Representative Office Of GIGA-BYTE Technology Co., Ltd.
in SERBIA & MONTENEGRO

WEB address : <http://www.gigabyte.co.yu>

- **GIGABYTE Global Service System**



To submit a technical or non-technical (Sales/Marketing) question, please link to :

<http://gts.gigabyte.com.tw>

Then select your language to enter the system.